



# PowerSafe® Two Wheel Tractors

## BCS 710 Rotavator

Manufactured by BCS S.p.A.



### Operating Instructions

Before commissioning the machine, read operating instructions and observe warning and safety instructions.

**PLEASE ALSO READ ORIGINAL  
BCS INSTRUCTION MANUAL**



 **TRACMASTER**  
*The landscape machinery specialists*

# Contents

<b>Page 3</b>	<b>Safety</b>
<b>Page 4</b>	<b>Controls Diagram &amp; Description</b>
<b>Page 5</b>	<b>Assembly Instructions</b>
<b>Page 6</b>	<b>How to Start Engine Operation How to Stop Engine</b>
<b>Page 7</b>	<b>Operating Hints</b>
<b>Page 8</b>	<b>Replacing the Tines</b>
<b>Page 9</b>	<b>Rotavator Sticker Positions</b>
<b>Page 10</b>	<b>Maintenance Guide</b>
<b>Page 11</b>	<b>Maintenance Programme</b>
<b>Page 12</b>	<b>Service Information</b>
<b>Page 14</b>	<b>Troubleshooting Guide</b>
<b>Page 15</b>	<b>Risk Assessment</b>
<b>Page 16</b>	<b>Service Record</b>
<b>Page 18</b>	<b>Machine Overview Diagram Vibration &amp; Sound Levels</b>
<b>Page 19</b>	<b>Manufacturer Information</b>

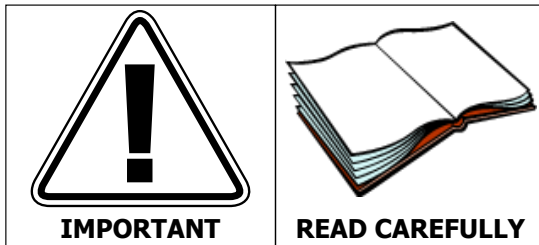

**No liability will be accepted for any damage caused to persons or property through failure to observe the operating and safety instructions.**

# Safety

**ALWAYS** read the original BCS manual first

**ALWAYS** start the engine in the open air

**DO NOT** smoke when refuelling

**DO NOT** mix OIL with the fuel

**ALWAYS** stop the engine before making any adjustments, refuelling, moving or cleaning, or when the unit is unattended

**USE ONLY** fuel from containers designed for this purpose - refuel outdoors only and replace the tank cap securely

**IN CASE** of petrol spillage move the machine away from the area of spillage and allow the petrol vapours to dissipate before starting the engine

**DO NOT** remove any safety guards that are fitted

**DO NOT** touch any moving parts or attempt any maintenance whilst the machine is running - **KEEP HANDS AND FEET AWAY**

**BEFORE** starting work clear the work area of any objects that could damage the machine

**DO NOT** allow children or anyone uninstructed to operate the machine - **KEEP ANIMALS AWAY**

**DO NOT** use on slopes or banks of more than 20°

**ALWAYS** wear suitable clothing to give personal protection including footwear that offers a good grip

**AVOID** wearing loose garments that may catch in moving parts

**KNOW** how to stop the machine in an emergency

**NEVER** interfere with any control settings on the engine

**NEVER** select reverse gear with your back to a wall or other immovable object

**IF A FAULT** develops **DO NOT** attempt any repair - immediately contact the supplier from whom the machine was obtained

**VISUALLY INSPECT** the machine before use - ensure all tines, nuts and bolts are tight and not worn or damaged and replace tines if necessary

**KEEP IN MIND** the operator is responsible for accidents or hazards occurring to people or property

## Controls

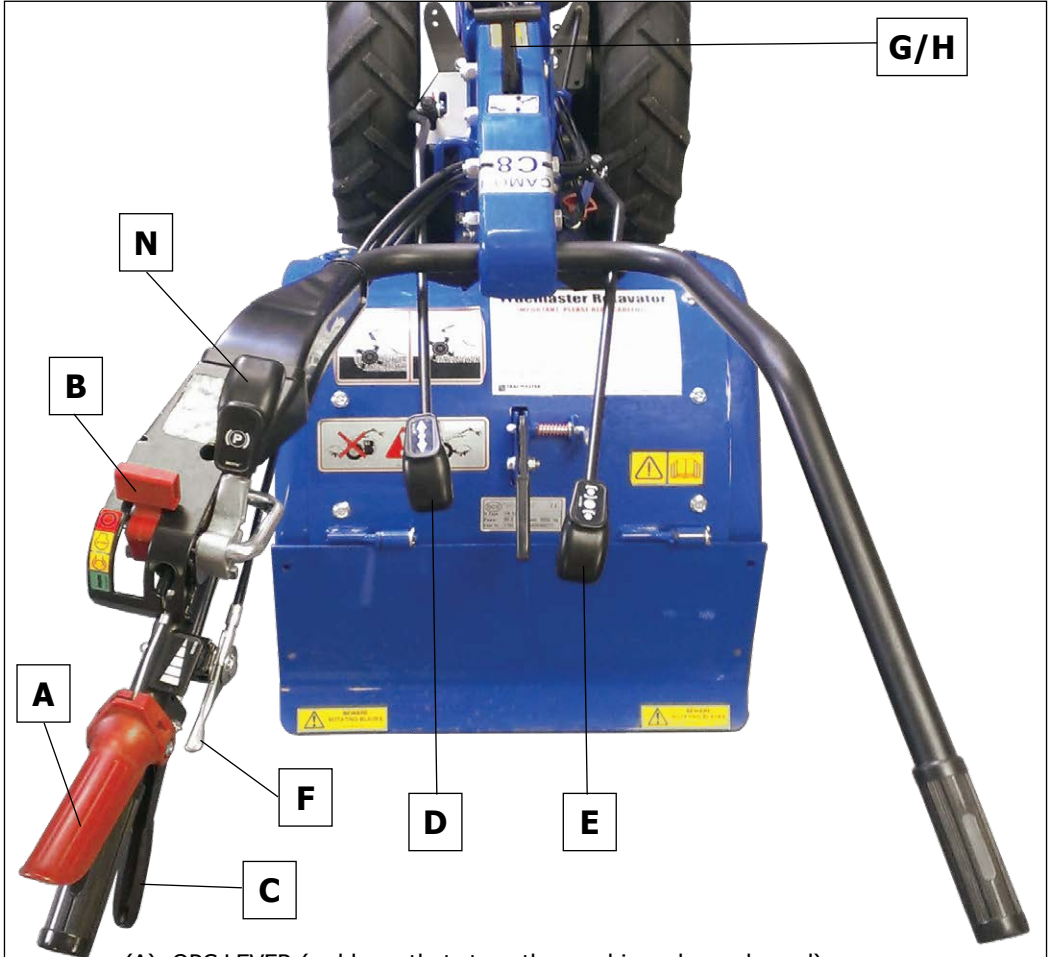

- (A) OPC LEVER (red lever that stops the machine when released)
- (B) ENGINE STOP LEVER
- (C) CLUTCH CONTROL LEVER
- (D) GEAR LEVER (the location of different gears are shown on the selector)
- (E) PTO LEVER (there is a safety device that prevents engagement with reverse gear)
- (F) THROTTLE LEVER
- (G) HANDLEBAR HEIGHT ADJUSTMENT LEVER
- (H) STEERING COLUMN SWIVEL LEVER
- (N) PARKING BRAKE LEVER

## Assembly Instructions

1. Remove the machine from its packing case.
2. Rotate the handlebar stem to the operating position and fit the handlebars - check operation and routing of cables.
3. Fit the wheels, ensuring the correct rotation (see diagram A below) and check the tyre pressures (20psi).
4. Fit the gearbox dipstick.
5. Assemble the rear flap on the digging unit ensuring the sticker labels are on the outside (see diagram B below) and attach the unit to the machine.
6. Check the engine oil level.
7. Follow the instructions in this manual to run the machine.
8. Read the original BCS instruction/operation manual.

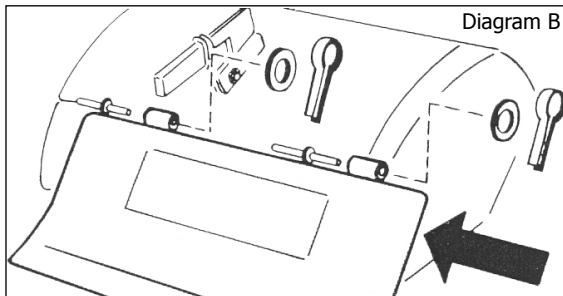
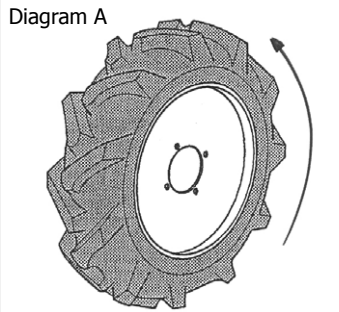

## To Start Engine

Using the dipstick provided, check the engine oil level. Top up with 10w/40 oil if necessary.

Check fuel level. Only use unleaded petrol from a clean container. Never re-fuel when the engine is hot or running. Leave 1" air space in the fuel tank.

Turn the fuel tap to 'ON' position, if the engine is cold set the choke lever to 'ON' position.

Before starting the engine ensure the gear lever (D) is in neutral position and the power take-off (PTO) lever is disengaged (E).

Apply half throttle (F).

Move the engine stop lever (B) to position 1 'ON'.

Pull the recoil start handle gently until it engages then give it a good strong pull to start the engine.

When the engine has started, release the choke lever after a few seconds and return the throttle lever (F) to idle position.

## Operation

Use handlebar adjuster (G) to set handlebar height.

Hold the handlebar and pull up the clutch lever (C).

Depress the red OPC lever (A) and select working speed 1 (D). NEVER select a higher wheel speed for work.

Ensure forward/reverse lever is in forward position (L).

Engage drive to the digging knives by pushing the PTO lever (E) forward.

Release clutch lever (C) slowly and fully, keeping the red machine stop lever depressed as the machine will stop if released.

Commence work.

## To Stop Engine

Close the throttle (F).

Engage clutch lever (C).

Locate gear lever (D) in neutral position.

Disengage drive to the digging knives by pulling the PTO lever (E) backwards.

Release clutch lever (C).

Release the red OPC lever (A) completely.

Move the engine stop lever (B) to position O 'STOP'.

**WARNING: THE EXHAUST COVER MAY BE HOT - DO NOT TOUCH.**

## Operating Hints

**CLEAR THE WORK AREA.** Long grass must be cleared and all debris removed.

**LET THE MACHINE DO THE WORK.** Excessive downward pressure on the handlebars may cause the machine to jump. Apply gentle pressure and the machine will find its own digging depth according to the type of ground.

If the ground is hard, position the depth adjuster centre knife on the top hole and make several passes until the desired depth is achieved.

If the wheel speed or PTO lever does not engage immediately, release clutch lever slightly and 'feel in' with the engine on tick-over. **DO NOT FORCE THE OPERATING LEVERS.**

Always pull in the clutch lever before engaging gear, digging unit or changing forward/reverse.

The clutch lever must be fully released when working. DO NOT operate the machine with the clutch lever partially engaged as serious damage may occur.

If the ground is hard then using a lower working speed will produce the best performance. If the soil is loose or sandy a higher working speed is best.

**DO NOT WORK ON SLOPES MORE THAN 20°.** If working on a slope, work across the slope pointing the machine slightly uphill.

### DO NOT ATTEMPT CULTIVATION ON:

- (i) Frozen or waterlogged ground as this will destroy the soil structure resulting in poor future drainage.
- (ii) Ground that is covered with thick foliage or high grass. Remove it by cutting down.

### DEPTH ADJUSTMENT

Digging depth changes are made through use of the central knife.

For shallow digging, set the lever all the way in.

To increase digging depth, raise the control lever.

Whilst rotavating, the handlebars can be offset to avoid walking on the cultivated soil, and adjusted in height for the comfort and safety of the operator.

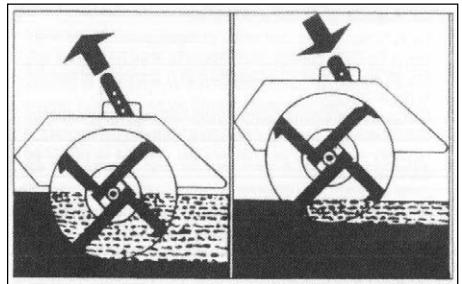

## Replacing the Tines

To replace the tines, it is necessary to remove the rotavator attachment from the power unit.

Once removed, turn the rotavator upside down to enable replacement of the tines.

**BEFORE REMOVING ANY TINES, FIRST LOOK CAREFULLY AT THE ORIENTATION OF THE TINES.**

We recommend replacing the tines one at a time so that you can use the remaining tines as a reference.

**IMPORTANT:** When replacing the tines, ensure that they are mounted with the cutting edge in the same position as shown in the picture to the right.

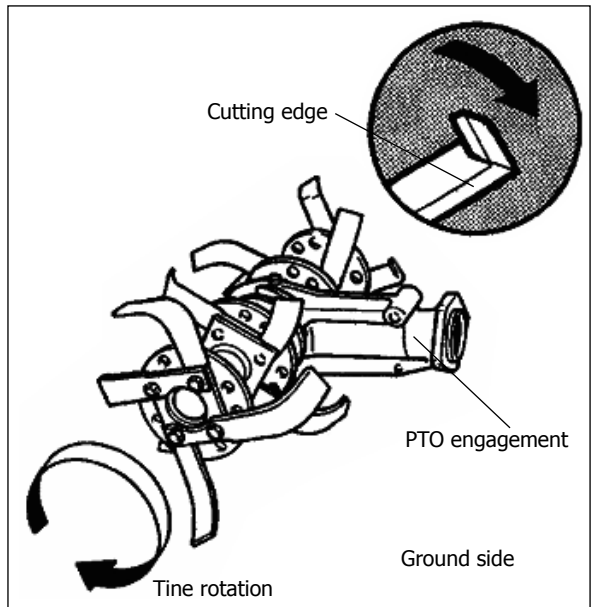
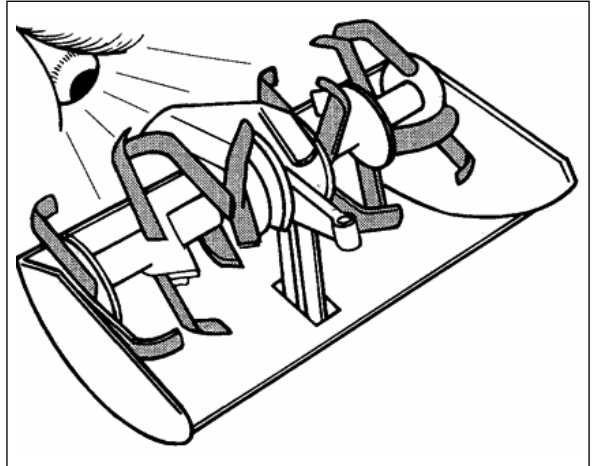



## Rotavator Sticker Positions



1. CE label  
(part no: 58046963)
2. Read manual  
(part no: 58057724)
3. How to use  
(part no: 580C0039)
4. Beware rotating blades  
(2 off part no: 58046922)
5. Adjustment  
(part no: 580C0054)
6. To operate the machine  
(part no: 810937)

**IMPORTANT:** The labels must be kept clean from dust and mud and must always be clearly visible and legible. They must be replaced if they are missing or illegible. New labels are available from Tracmaster's spare parts department.

## Maintenance Guide

For engine maintenance please refer to engine manufacturers manual.

After every hour of operation stop the engine and remove the spark plug cap. Check engine oil level (recommended oil SAE 10w/40). Before checking the oil level ensure the machine is level.

Remove all foreign matter from the digging knives assembly e.g. wire, string, grass etc.

After every 100 hours of use, or once a year (whichever is sooner), check that the oil level in the rotavator transmission is within 50mm (2") of the hole.

To perform this operation, remove the bolts that attach the support rod to the rotavator transmission and the depth handle to the central knife. Raise the rotavator hood, remove the plug and check the oil level, making sure the machine is level. If necessary top up with SAE 80w/90 EP gear oil. Reassemble the unit by performing the operations in reverse.

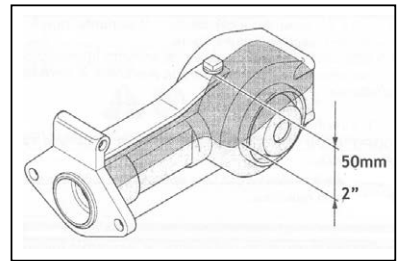

Remove the gearbox unit dipstick and ensure the oil reaches the top level mark, if necessary top up with API GL-5 80w/90 gear oil (see pages 12-13 for more details).

Replace the spark plug cap.

Do not turn the machine on its side for cleaning.

## Maintenance Programme

	<b>OPERATION</b>	<b>EVERY DAY</b>	<b>EVERY WEEK</b>	<b>EVERY YEAR or 100 HOURS</b>
<b>ENGINE</b>	Check engine oil level 10w/40 See separate engine manual	X	X	
<b>GEARBOX &amp; CONTROLS</b>	Check gearbox oil level (see pages 12-13)	X	X	
	Check nuts & bolts	X	X	
	Ensure clutch cable has free play		X	
	Check tyre pressure (20psi)		X	X
	Lubricate control cable/linkages		X	
	Check control cable operation		X	
	Check operation of safety devices		X	
	Change gearbox oil (see pages 12-13)			
	Grease gear speed detent ball		X	X
<b>DIGGING UNIT</b>	Check condition of centre knife		X	
	Tighten nuts & bolts on knives	X	X	
	Check nuts & studs on side flange	X	X	
	Check drive unit oil level EP90		X	X

**NOTES:**

- \* Pressure washing machines removes lubricating grease as well as dirt.

It is imperative all linkages, especially the wheel speed lever detent ball and PTO swivel joint, are kept well greased otherwise they will become difficult to operate and cause damage.

- \* DO NOT allow maximum engine speed to exceed 3600rpm.

## Service Information

### Every Week

- With the machine on a level surface, check the gearbox oil level, top up as necessary using the correct oil as listed below. The gearbox oil level should reach between the two notches on the dipstick (*fig. 2, C*).

### After the First 2 Weeks or 30 Hours of Work

- Replace the gearbox **oil filter** **ONLY**, (*fig. 1, A*), part number 58056249.
- Check the gearbox oil level using the dipstick (*figs. 1 & 2, C*), run the machine for 2-3 minutes and recheck gearbox oil level, top up as necessary using the correct oil as listed below.

### Every 100 Hours of Work or 12 Months

- Change the gearbox oil by removing the gearbox drain plug (*fig. 3, B*).
- Replace the gearbox oil filter (*fig. 1, A*), part number 58056249.
- Clean the gearbox drain plug and refit.
- Fill gearbox using the correct oil and quantity as listed below.
- Check the gearbox oil level, run the machine for 2-3 minutes and recheck gearbox oil level.

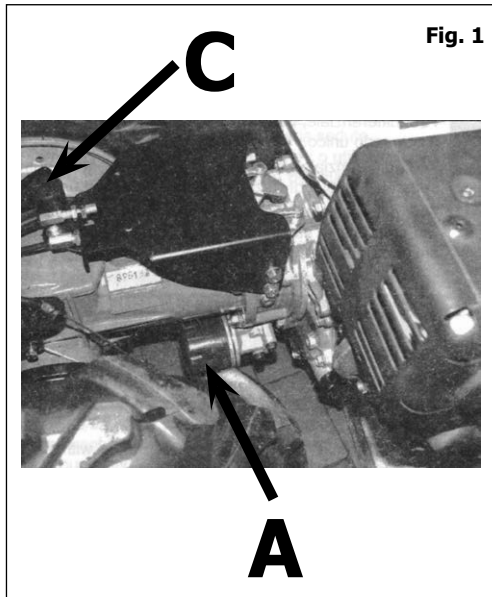

#### To replace the oil filter (**fig. 1, A**)

1. Using the correct spanner, remove the filter.
2. Smear a film of oil on the rubber gasket of the new filter.
3. Mount the new filter, screwing and tightening by hand only.

# Service Information

## Gearbox Oil Quantities

BCS 710 = approx 2.3 litres

## Oil Type

Fuchs	Titan Hyp 90
Valvoline	80w-90 GL-5
Morris	EP80w/90 API GL5
Castrol	EPX 80w-90
Motorex	Hypoid SAE 80w/90 API GL5
Millers	Hypoid 80w90 GL5
Comma	EP80w-90 GL5
Agip	Rotra MP 80w-90
Rock Oil	SD API GL5 80w/90

Alternatively any oil meeting API GL-5 80w/90 specification may be used.

Multigrade engine oil must **NOT** be used.

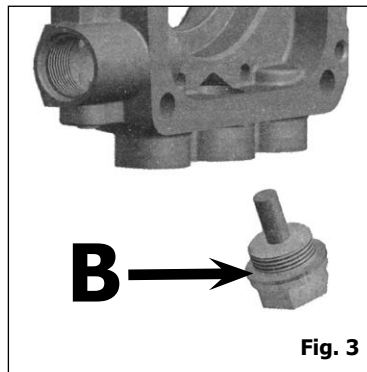
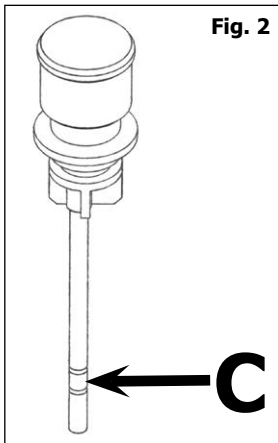

## Troubleshooting Guide

<b>PROBLEM</b>	<b>POSSIBLE CAUSE</b>	<b>REMEDY</b>
Unable to select gear	Pressure washing has removed lubrication of gear lever detent ball.	Grease the detent ball and quadrant.
Unable to pull engine over	Machine has been tipped on side for cleaning and engine oil has filled the cylinder bore causing a hydraulic lock.	Remove spark plug and air filter. Stand to one side and pull over engine to clean out oil. Change engine oil and air filter. Clean spark plug.
Machine suddenly leaps forward whilst cultivating	New set of tines has been fitted the wrong way round.	Check fitting and refit if necessary.
	Centre knife is worn out or missing.	Check centre knife and replace if necessary.
	Centre knife lifted too high on hard ground.	Lower centre knife.
No drive to wheels or digging unit	Check gearbox oil level.	Top up if necessary with API GL-5 80w/90 oil (see page 13).
Engine smokes	There may be petrol in the engine oil due to fuel tap being left on during transportation.	Change engine oil.
	Contaminated air filter.	Replace element.

### **NOTES:**

\* Pressure washing machines removes lubricating grease as well as dirt.

It is imperative all linkages, especially the wheel speed lever detent ball and PTO swivel joint, are kept well greased otherwise they will become difficult to operate and cause damage.

\* DO NOT allow maximum engine speed to exceed 3600rpm.

## Risk Assessment

HAZARDS	RISK LEVEL	ACTION NEEDED
General		The machine should only be used by trained operators.
Machine tipping over	Low	Do not use on slopes over 25°.
Machine jumping	High	<p>Ensure the centre knife is in good condition and adjusted to suit the ground conditions. Use the depth adjuster located on top of the rotavator to adjust the centre knife.</p> <p>NEVER apply excessive downwards pressure on the handlebars.</p>
Machine running away	Low	Red OPC lever disengages the drive to the implement if the operator releases the handlebars. Always check operation before use.
Lacerations	Medium	Remove the spark plug cap before carrying out any maintenance or cleaning. Always wear gloves when cleaning the tines or removing debris.
Machine reversing and jamming operator against immovable object	High	Never reverse the machine with your back to a wall or similar object.
Burns	High	Be very careful of a hot exhaust. Turn off the machine before refuelling. Allow 1" air space in the fuel tank.
Flying objects	Low	<p>Ensure the back flap moves easily and follows the contour of the ground to prevent small stones being thrown back. Always wear suitable safety footwear.</p> <p>NEVER use the back flap as a grader.</p>
Handlebar adjustment	Low	Always set the height and sideways position before operating the machine - never while it is moving.
Foot injuries	Medium	The machine has a safety device to prevent the reverse speed and tine drive being engaged simultaneously. Ensure all safety devices are in place before using the machine. Always wear suitable safety footwear.

## Service Record

To ensure your machine is kept in peak condition, we recommend that you have it serviced regularly by one of Tracmaster's Authorised Agents.

To find out who your local Authorised Agent is, contact Tracmaster on 01444 247689.

### SERVICE SCHEDULE

#### First 2 Weeks or 30 Hours of Work - whichever is sooner (see page 12)

First PowerSafe® oil filter replacement (part number 58056249)

Check and/or restore gearbox oil level (API GL-5 80w90 specification)

**Signed:**

**Date:**

#### Every 12 Months or 100 Hours - whichever is sooner (see page 12)

Implement transmission oil replacement (API GL-5 80w90 specification)

Engine oil replacement (SAE 15w/40)

**Signed:**

**Date:**

#### 24 Months or 200 Hours

**Signed:**

**Date:**

#### 36 Months or 300 Hours

**Signed:**

**Date:**

#### 48 Months or 400 Hours

**Signed:**

**Date:**

#### 60 Months or 500 Hours

**Signed:**

**Date:**

#### 72 Months or 600 Hours

**Signed:**

**Date:**

#### 84 Months or 700 Hours

**Signed:**

**Date:**

#### 96 Months or 800 Hours

**Signed:**

**Date:**

#### 108 Months or 900 Hours

**Signed:**

**Date:**



**Register your warranty online now!**

**[www.tracmaster.co.uk](http://www.tracmaster.co.uk)**

- **Complete the online warranty form, or the enclosed FREEPOST card.**
- **View and download spare parts diagrams.**
- **View and download owners manuals and operating instructions.**
- **See working video clips of machines from our BCS and CAMON ranges.**

 **TRACMASTER**  
*The landscape machinery specialists*

**T: 01444 247689**

## Machine Overview Diagram

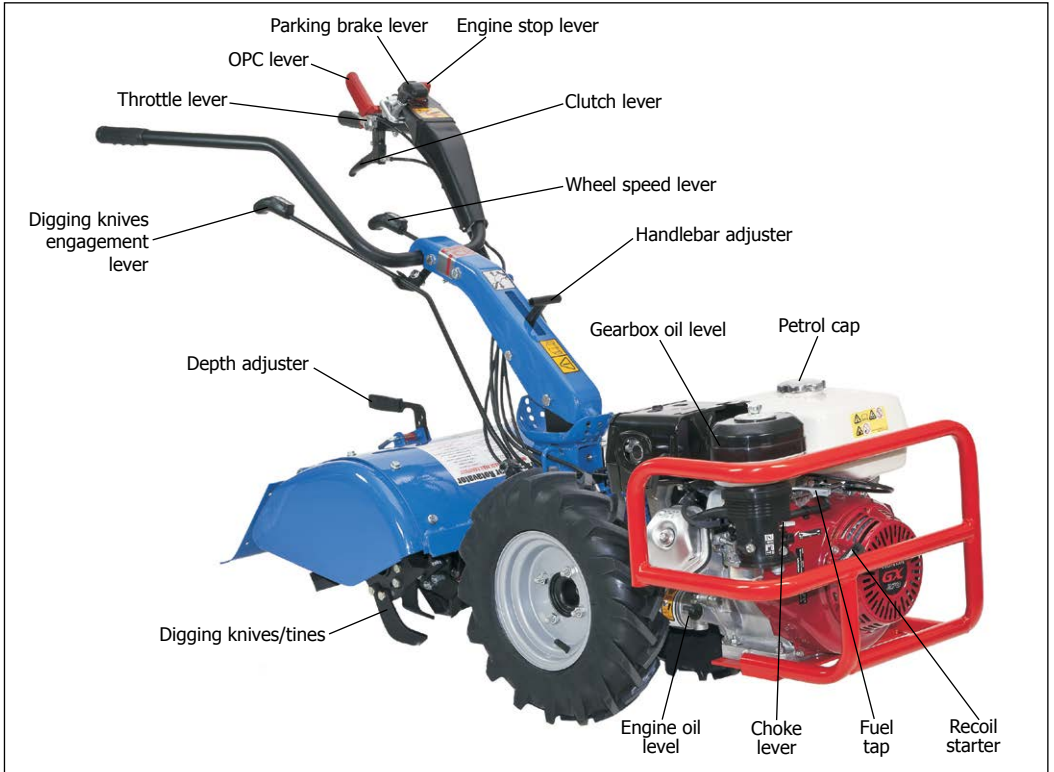

## Vibration & Sound Levels

MACHINE	RPM	VIBRATION M/SEC <sup>2</sup> (3 AXIS)	SOUND LEVEL dB(A)
BCS 710	3100	3.13	85.0

## Manufacturer Information

This machine is manufactured in Italy by BCS S.p.A.

Tracmaster Ltd is the UK distributor for this model, the BCS 710.

BCS S.p.A. has been at the forefront of developing cutting edge agricultural machinery since its formation in 1943, when their founder developed a self-propelled motor mower. Tracmaster Ltd has been the UK distributor for BCS pedestrian equipment since 1984.

Please ensure you read the original manufacturer's manual before operating this machine.



### **BCS S.p.A.**

V.le Mazzini, 161

20081 Abbiategrasso (MI)

Italy

Tel: +39 02 9482 1

Fax: +39 02 9496 0800

Email: [info@bcs-ferrari.it](mailto:info@bcs-ferrari.it)

Website: [www.bcsagri.it](http://www.bcsagri.it)

© Tracmaster Ltd 2017.

Specifications are subject to change without prior notice.



Tracmaster Ltd, Sovereign Centre, Victoria Road, Burgess Hill RH15 9LR

T: +44 (0) 1444 247689 F: +44 (0) 1444 871612

W: [www.tracmaster.co.uk](http://www.tracmaster.co.uk) E: [info@tracmaster.co.uk](mailto:info@tracmaster.co.uk)