

# Portable & Compact Glazing

## Oscar 280 [280kg] Optimum Strength Compact Articulated Robot

GGR Group's exclusive range of Oscar glazing robots offer a revolutionary sideshift feature for shuffling glass into millimetre perfect position, without the need for realigning the whole machine.

The smallest robot in the range, the Oscar 280, delivers unparalleled lifting capacity for its size with the ability to handle loads of up to 280kg, making it perfect for tricky internal glazing tasks. With a width of just 630mm, passing through doors is no problem for the Oscar 280 which also features a flexible head that can be slewed sideways 90° left and right.

Precision installation of glass panels is made easy with a robotic lifting head that powered tilts and manually rotates up to 180°. The Oscar 280 comes complete with a cable remote control and small wheeled outriggers for extra stability when lifting and transporting loads.

**Reference Code**  
**GRG35**



Cable remote control as standard

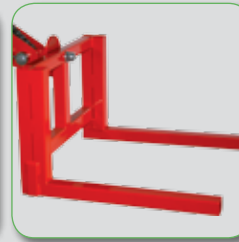

Optional fork lift attachment

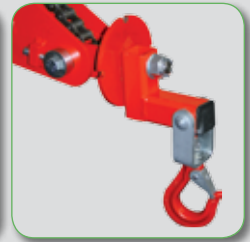

Optional hook attachment

### Technical Specifications

<b>Safe working load</b>	capacity jib 1: capacity jib 2:	280kg 170kg
<b>Suitable for lifting</b>	material properties: surface: example:	gastight / non-porous smooth glass, plastic boards, ceramic plates
<b>Weight</b>	with counterweights: without counterweights:	505kg 292kg
<b>Width</b>	width:	630mm
<b>Travelling length</b>	length:	2160mm
<b>Travelling height</b>	height:	1388mm
<b>Number of suction cups</b>	cups:	4
<b>Powered head tilt</b>	powered head tilt:	90° up & down
<b>Powered lateral sideshift</b>	powered lateral sideshift:	100mm
<b>Manual pad frame rotation</b>	rotation:	180° lockable left & right
<b>Manual head slew left &amp; right</b>	manual head slew:	90° left & right
<b>Boom in &amp; out</b>	boom in & out:	500mm
<b>Vacuum system</b>	dual circuit:	2 pumps, 2 vacuum reserve tanks
<b>Power requirements</b>	rechargeable battery: pump:	110v/240v charger 24v DC (2 x 12v)

### Rated Loads Diagram

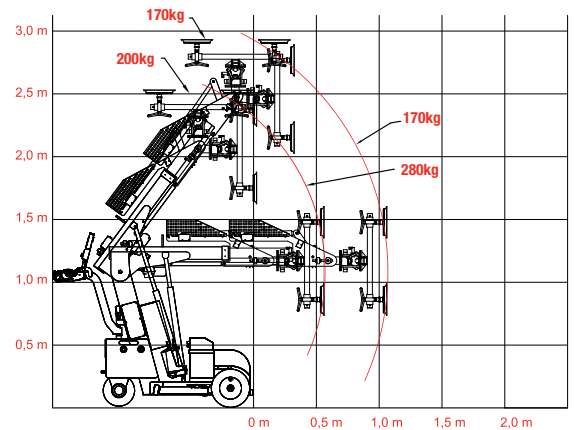

# Class Lifting Robot

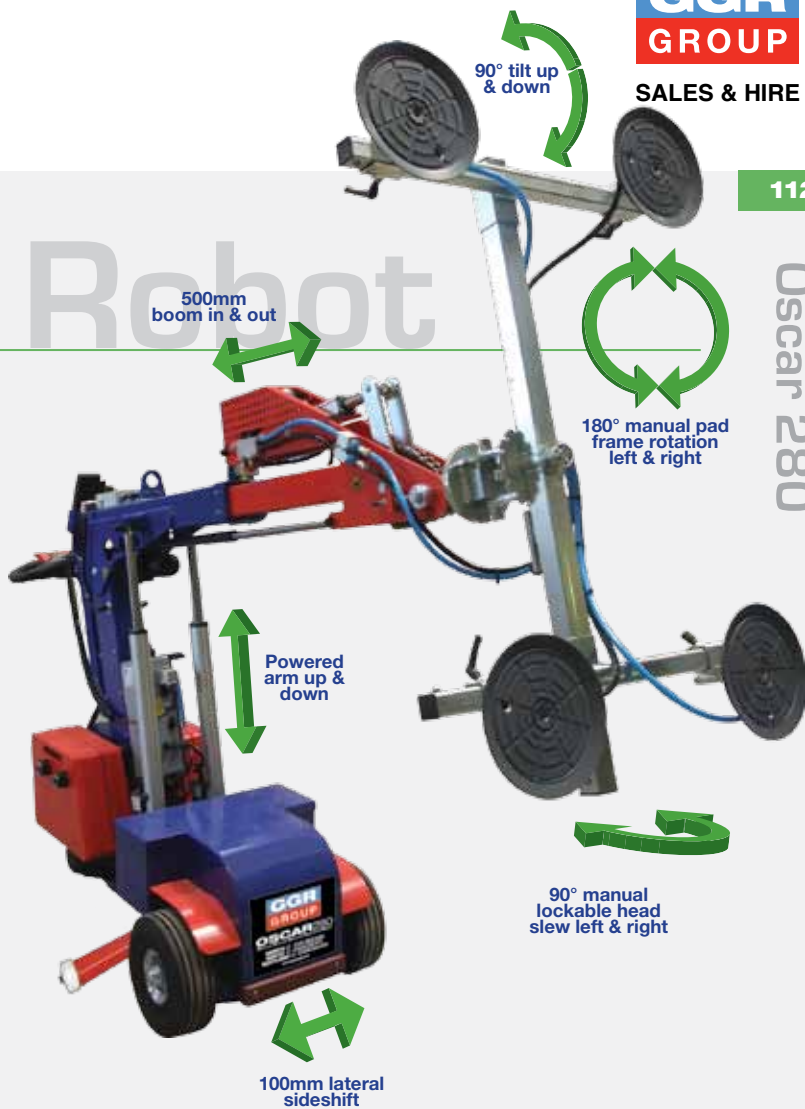

Optional low marking tyres



Electric rear wheel drive



Oscar 280 lateral sideshift 100mm



Optional magnetic light for improved safety in low light areas

## Technical Data (mm)

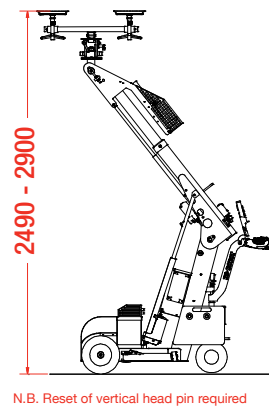
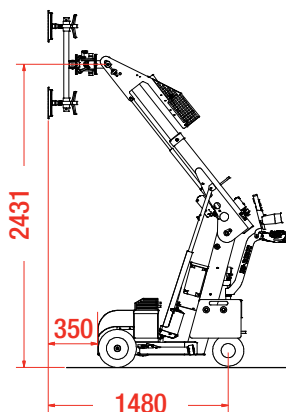
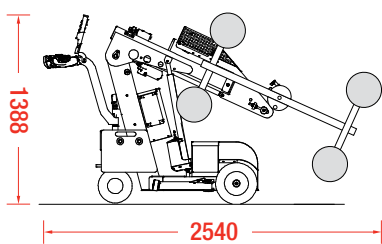
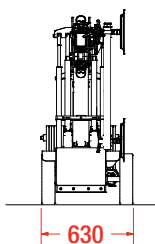
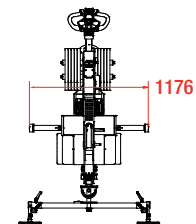
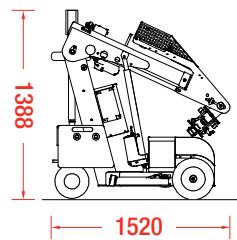
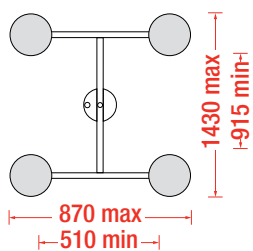
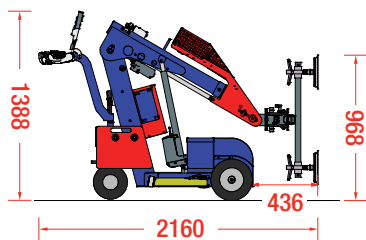
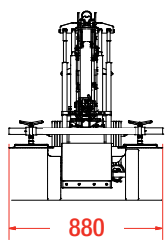

N.B. Reset of vertical head pin required