

HA20 LE - HA20 LE PRO - HA61 LE - HA61 LE PRO TOUCH SCREEN DISPLAY

For online reference and to download the manuals for your machines HAULOTTE®, go to :
<https://www.e.technical-information.com>
or, scan the QR Code below :



Operator's manual

HA20 LE - HA20 LE PRO - HA61 LE - HA61 LE PRO

TOUCH SCREEN DISPLAY



A

FOREWORD

- 1 - User responsibility 8**
 - 1.1- Owner's responsibility 8
 - 1.2- Employer's responsibility 8
 - 1.3- Trainer's responsibility 8
 - 1.4- Operator's responsibility 9
- 2 - Safety 10**
 - 2.1- Safety instructions 10
 - 2.1.1- Incorrect use 10
 - 2.1.2- Falling Hazards 10
 - 2.1.3- Overturning / Tip-over Hazards 12
 - 2.1.4- Risk of electric shock (electrocution) 14
 - 2.1.5- Explosion / Fire Hazards 16
 - 2.1.6- Crushing / Collision Hazards 16
 - 2.1.7- Risk of involuntary movements 17
- 3 - Safety inquiries 17**
- 4 - Incident notification 18**
- 5 - Compliance 19**
 - 5.1- Product modification 19
 - 5.1.1- Implementing manufacturer safety campaigns 19
 - 5.2- Product specifications 19
 - 5.3- Change of Ownership Notification 20
 - 5.4- Declaration of conformity 21

B

FAMILIARIZATION

- 1 - General safety 25**
 - 1.1- Intended use 25
 - 1.2- Decal content 25
 - 1.3- Symbols and colors 26
 - 1.4- Level of severity 26
 - 1.5- Symbols legend and definitions 27
- 2 - Models description 28**
- 3 - Primary machine components 30**
 - 3.1- Layout 30
 - 3.2- Ground control box 34
 - 3.2.1- Layout 34
 - 3.2.2- Touch screen display 38
 - 3.3- Platform control box 64
 - 3.3.1- Layout 64
 - 3.3.1.1- Battery charging indicator (90) 67
 - 3.3.2- Display Panel (LED'S 101 - 117) 68
- 4 - Performance Specifications 70**
 - 4.1- Technical characteristics 70
 - 4.2- Engine specifications 72
 - 4.2.1- Kubota engines 72
 - 4.3- Working area / Range of motion 73
- 5 - Decals and markings locations 74**

CONTENTS



C

PRE-OPERATION INSPECTION

- 1 - Recommendations 85**
- 2 - Working area assessment 85**
- 3 - Inspection and Functional test 86**
 - 3.1- Daily inspection 86
- 4 - Safety functional checks 89**
 - 4.1- E-Stop button check 89
 - 4.2- Activation of controls 89
 - 4.3- Fault detector 90
 - 4.3.1- Indicators/LED's test 90
 - 4.3.2- Buzzers test 90
 - 4.4- Automatic engine cut-out 91
 - 4.5- Overload sensing system 91
 - 4.6- Oscillating axles (if equipped)if equipped. 91
 - 4.7- Slope warning device 92
 - 4.8- Travel speed limitation 92
 - 4.9- On-board electronics 93
 - 4.10- Load selection system (if fitted). 93

D

OPERATION INSTRUCTIONS

- 1 - Operation 95**
 - 1.1- Introduction 95
 - 1.2- Major description 95
 - 1.3- Operation from the ground control box. 95
 - 1.4- Operation from the platform control box. 97
 - 1.5- Mode operation 99
 - 1.5.1- Full Electric mode. 99
 - 1.5.2- Auto mode 99
 - 1.5.3- Forced engine mode 100
 - 1.5.4- Overview of mode operation 101
- 2 - Ground control box 102**
 - 2.1- To start and stop the machine 102
 - 2.2- Movement control 103
- 3 - Platform control box. 105**
 - 3.1- To start and stop the machine 105
 - 3.1.1- To start the machine. 105
 - 3.1.2- To stop the engine 105
 - 3.2- Movement control 106
 - 3.3- Additional controls 108
 - 3.3.1- Activ' Lighting System 108
 - 3.3.2- Dual load selector (if fitted). 108



4 - Rescue and emergency procedures	109
4.1 - In case of power loss	109
4.2 - To rescue operator in platform	110
4.2.1 - Operation of overriding system from ground control box	110
4.3 - No power available	110
5 - Transportation	112
5.1 - Transport configuration	112
5.2 - Machine stowage for transport - HA20 LE - HA20 LE PRO HA61 LE - HA61 LE PRO	113
5.3 - Unloading	114
5.4 - Towing	115
5.4.1 - Disengaging the drive hubs	115
5.4.2 - Re-engaging the drive hubs	116
5.5 - Storage	117
5.6 - Lifting operation	119
6 - Cold Weather Recommendations	120
6.1 - Engine oil	120
6.2 - Hydraulic oil	121
7 - Battery care and maintenance	122
7.1 - Battery recharge	122
7.1.1 - On-board charger	122
7.1.2 - Battery charging	123
7.2 - Battery care and maintenance	127
7.2.1 - Filling batteries	127
7.2.1.1 - Procedure to fill the batteries manually	129
7.2.1.2 - Procedure to fill the batteries automatically - Option	130
7.2.2 - Desulfation charge	131

E

GENERAL SPECIFICATIONS

1 - Machine dimensions	132
2 - Center of gravity	134
3 - Major component masses	135
4 - Acoustics and vibrations	135
5 - Wheel/Tire assembly	136
5.1 - Technical specifications	136
5.2 - Inspection and maintenance	136
6 - Options	139
6.1 - Platform	139
6.2 - Glazier's kit	140
6.2.1 - Description	140
6.2.2 - Characteristics	140
6.2.3 - Safety precautions	140
6.2.4 - Pre-operation inspection	140
6.2.5 - Operation	141
6.2.6 - Assembly / Dis-assembly	142
6.2.7 - Specific decals	143
6.3 - Plumber's kit	144
6.3.1 - Description	144
6.3.2 - Characteristics	144
6.3.3 - Safety precautions	144
6.3.4 - Pre-operation inspection	144
6.3.5 - Operation	145
6.3.6 - Assembly - Dis-assembly	145
6.3.7 - Specific decals, optional	147
6.4 - Activ' Shield Bar - SECONDARY GUARDING SYSTEM (If fitted)	148
6.4.1 - Description	148
6.4.2 - Characteristics	148
6.4.3 - Safety precautions	149
6.4.4 - Pre-operation inspection	150
6.4.5 - Operation	150
6.4.6 - Specific decals	151

CONTENTS



F**MAINTENANCE**

1 - General	153
2 - Maintenance Schedule	154
3 - Inspection program	155
3.1- General program	155
3.2- Daily inspection	155
3.3- Periodic inspection	156
3.4- Reinforced inspection	156
3.5- Major inspection	156
4 - Repairs and adjustments	157

G**OTHER INFORMATION**

1 - Conditions of warranty	159
2 - Subsidiary contact information	159
2.1- California warning	160

H**INTERVENTION REGISTER**

1 - Intervention register	163
--	------------



A - Foreword

You have just purchased a HAULOTTE® product and we would like to thank you for your business.

The aerial work platform is a device for lifting people designed and manufactured with the intent to enable users to access overhead elevated temporary workplaces with the necessary tools and equipment. All other uses or alterations/modifications to the aerial work platform must be approved by HAULOTTE®.

This manual shall be considered a permanent component of the machine and shall be kept with the aerial work platform in the designated Manual Holder, at all times.

Safe operation of this product can only be assured if you follow the operating instructions contained in this manual. To ensure the safe and appropriate use of this equipment, only trained personnel are authorised to use and carry out maintenance on the aerial work platform.

We would particularly like to draw your attention to 2 essential points :

Comply with safety instructions.

use this equipment within the performance limits specified by this user manual.

With regard to the designation of our equipment, we stress that this is purely for commercial purposes and not to be confused with the technical specifications. Only the specifications in this manual should be used to study the suitability of the equipment for the intended use.

This operator's manual is specific to the HAULOTTE® products listed on the cover page of this manual.



Original language and version :

Manuals in English and French are the original instructions. Manuals in other languages are translations of the original instructions.

The user manual does not replace the necessary training that is required for all of this machine's operators. HAULOTTE® has compiled this manual to assist in safe and efficient operation of the products covered in the manual.

The manual must be available to all operators and must be kept in a legible condition. Additional copies can be ordered from HAULOTTE Services®.

Stay Safe and keep working with HAULOTTE® !

For online reference and to download the manuals for your machines HAULOTTE®, go to :

<https://www.e-technical-information.com>

or, scan the QR Code below :

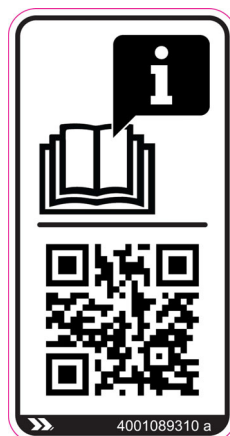

A - Foreword

1 - User responsibility

1.1 - OWNER'S RESPONSIBILITY

The owner (or hirer) has the obligation to :

- To inform operators of the instructions contained in the Operator's Manual.
- Follow local regulations regarding operation of the machine.
- Replace all manuals or labels that are missing or in poor condition. Additional copies can be ordered from HAULOTTE Services®.
- To establish a preventive maintenance program in accordance with the manufacturer's recommendations, taking into account the environment and severity of use of the machine.
- To perform periodic inspections in accordance with HAULOTTE® recommendations and local regulations.

All malfunctions and problems identified during the inspection shall be corrected before the aerial work platform is returned to service.

1.2 - EMPLOYER'S RESPONSIBILITY

The employer (or plant superintendent) is required :

- To train and check the training of users.
- To authorise the trained user(s) to use the machine.
- To inform and familiarize the operator with the local regulations.
- Forbid anyone from operating the machine if :
 - Under the influence of drugs, alcohol, etc.
 - Subject to fits, convulsions, dizziness, etc.

1.3 - TRAINER'S RESPONSIBILITY

- The trainer must be qualified to provide training to operators in accordance with applicable local regulations.
- The training must include all of the instructions in this manual.
- The training must be given in an obstacle-free area until the trainee is considered competent as defined by the training program undertaken.

A - Foreword

1.4 - OPERATOR'S RESPONSIBILITY

The operator has the obligation to :

- Read and understand the contents of this manual and familiarize himself/herself with the decals affixed on the machine.
- To inspect the machine before use according to HAULOTTE®'s recommendations..
- Inform the owner (or hirer) if the manual or any decals are missing or are not legible.
- Inform the owner (or hirer) of any machine malfunction.

Operators must ensure that the inspections have been carried out by the owner and that they can use the machine for the purpose intended by the manufacturer.



All users (driver, passenger, maintainer, transporter, etc.) must familiarise themselves with the emergency controls and machine operation in case of an emergency.

The operator has the obligation to stop using the machine in the event of malfunction or safety problems on the machine or in the work area and report the problem immediately to his/her supervisor.

A

B

C

D

E

F

G

H

I

A - Foreword

2 - Safety

2.1 - SAFETY INSTRUCTIONS

2.1.1 - Incorrect use

- Do not use the machine outside of the conditions specified in this manual.
 - Do not use the machine as a crane, material lift or elevator.
- 
- Do not use the work platform as a hoisting machine (crane) by suspending a load outside of the platform.
 - Do not tie the boom or platform to an adjacent fixed or mobile structure.
 - Do not use/operate the machine when alone. A survey person or immediate Supervisor must be present on the ground in case of emergency.
 - Do not use a faulty or poorly maintained machine. Remove defective/damaged machine from service.
 - Do not climb onto the compartment covers of the machine.
 - Do not replace items critical to machine stability with items of different weight or specification.
 - Do not replace the wheels installed in the factory with wheels with different characteristics
 - Do not alter or disable machine components that in any way affect safety and stability.
 - Do not disable the safety devices.
 - Do not use the machine if a label is missing or illegible.
 - Do not damage, modify or hide machine labels or inscriptions.

2.1.2 - Falling Hazards

N.B.:-The guardrail is the main protection system against falls from the mobile lifting platform (PEMP).

Before commencing operation :

- Ensure that guard rails are correctly installed and secured.
 - Ensure that gate or sliding bar is in its securely locked position.
 - If using a machine that has a swing gate, check that the entry gate closes by itself and gate latches and locks.
- 
- Remove oil or grease from the steps, floor, handrail and the guardrails.

A - Foreword

- Clean the floor of the platform (no debris).

To enter or exit from the platform :

- The machine must be completely stowed (Access configuration).
- Face the machine to access the opening to the platform.
- Keep 3 points of contact (both hands and a foot) on the steps and the guardrail.
- Keep fingers away from moving parts near entry gate.



When in the platform :

- Where personal fall protection equipment (FPE) is required by the employer, a competent authority or local regulations, we recommend using a full harness with a safety line.
- Personal fall protection equipment must only be fastened to approved fall protection anchoring points on the platform provided for this purpose.
- Refer to this decal located on the platform.
- Safety lines must never be attached to an object or structure outside of the work platform.
- Hold on securely to the guardrails.
- Always keep your feet firmly on the floor of the platform.
- Do not sit, stand, or climb on the platform guard rails.
- Do not lean on the gate or sliding bar.
- Do not lean over the guard rails or climb over them. Only work in the platform area within the guard rails.
- Do not exit the platform until it is in the completely stowed position.
- Do not use the guardrail as a means of access to climb in or out of the platform.

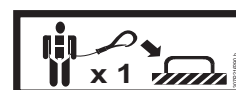

A - Foreword

2.1.3 - Overturning / Tip-over Hazards

Before positioning and operating the machine :

- Ensure that the surface is capable of supporting the machine weight including the rated capacity. Check the load bearing capacity of the supporting ground.
- Remain vigilant of driving direction reversal at the platform. Check the driving direction with the help of the red or green arrow on the chassis relative to the red and green arrows on the platform control box.
- Do not exceed the maximum rated capacity that includes the weight of both material and allowed number of occupants. Do not exceed the allowable number of occupants.
- Do not increase the working height (using extensions, ladder, etc.).
- Do not place ladders or scaffolds in the platform or against any part of this machine.
- Position loads uniformly in the centre of the work platform.
- Do not use the machine at wind speeds that are above the permissible threshold. Refer to the display on the work platform to view the permissible wind speed.
- Do not increase the surface area of the platform exposed to wind. This includes adding panels, mesh, banners. Failure to follow this instruction may lead to a loss of stability and as a result, the machine could tip over.
- Do not raise the platform or move the machine with the platform raised on a slope with a gradient greater than the machine's permissible limit.
- Do not rotate the turret while on a slope greater than :
 - 25 % with a platform load of below 250 kg(551 lb).
 - 20 % with a platform load of below 350 kg(771 lb).
- Do not drive the machine on slopes or grades exceeding the specified limits.
- Do not replace components critical to stability with components of different weight or specification.
- Do not use the machine with material or objects hanging from the guardrail or the boom.
- Do not pull or push towards any object outside of the platform. Do not exceed the maximum allowable side force stated in the performance specifications.
- Do not use the machine to support any external structure.
- Do not use the machine to tow other machines or to drag materials.



A - Foreword

Using the machine on a slope



Do not drive the machine on slopes with gradients exceeding the authorised transversal and lateral limits for the machine.  **Section B 4.1 - Technical characteristics.**

WIND: the aerial work platform can be used up to the maximum wind speed indicated in the specifications in this manual. To identify the local wind speed, use the Beaufort scale below, a wind gauge or an anemometer.

N.B.:- The Beaufort scale of wind force is accepted internationally and is used when communicating weather conditions. A wind speed range at 10 m (32 ft 9 in) above flat, clear land is associated with each degree.

Beaufort scale

Force	Meteorological description	Observed effects	m/s	km/h	mph
0	Calm	Smoke rises vertically.	0 - 0,2	0 - 1	0 - 0,62
1	Very light breeze	Smoke indicates the wind direction.	0,3 - 1,5	1 - 5	0,62 - 3,11
2	Light breeze	Wind felt on the face. Leaves rustle. Weather vanes turn.	1,6 - 3,3	6 - 11	3,72 - 6,84
3	Slight breeze	Leaves and small twigs in constant motion. Flags move slightly.	3,4 - 5,4	12 - 19	7,46 - 11,8
4	Nice breeze	Raised dust and loose papers. Small branches are moved.	5,5 - 7,9	20 - 28	12,43 - 17,4
5	Nice breeze	Small trees in leaf to sway. Crested wavelets form on inland waterways.	8,0 - 10,7	29 - 38	18,02 - 23,6
6	Cool wind	Large branches in motion. Power lines and chimneys 'sing'. Umbrellas used with difficulty.	10,8 - 13,8	39 - 49	24,23 - 30,45
7	Near gale	Whole trees in motion. Inconvenience felt when walking against wind.	13,9 - 17,1	50 - 61	31 - 37,9
8	Gale	Some branches break. Generally we cannot walk against the wind.	17,2 - 20,7	62 - 74	38,53 - 45,98
9	Strong gale	The wind causes slight damage to buildings. Tiles and chimney stacks are blown off.	20,8 - 24,4	75 - 88	46,60 - 54,68

A - Foreword

2.1.4 - Risk of electric shock (electrocution)



Risk of death or serious injuries.

The machine is not electrically insulated and does not provide protection from contact or proximity to electrically charged conductors.

Always position all parts of the aerial work platform, the occupants, accessories and tools at a reasonable distance from power lines to ensure that no part of the work platform accidentally comes into contact with a power line.

Apply local regulations pertaining to safety distances. If this is not possible, follow the distances in the table below at a minimum :

Minimum safe approach distances

Electric voltage	Minimum safety distance	
	Mètre	Feet
0 - 300 V	Avoid contact	
300 V - 50 kV	3	10
50 - 200 kV	5	15
200 - 350 kV	6	20
350 - 500 kV	8	25
500 - 750 kV	11	35
750 - 1000 kV	14	45

- Do not operate the machine when close to live power lines, consider the movement of the machine and the sway of the electric power lines particularly in windy conditions.
- Do not operate the machine during lightning, thunderstorms, snow/ice or any weather condition that could compromise operator safety.
- Do not use the machine as a ground for welding.
- Do not weld on the machine without first disconnecting the battery terminals.
- Always disconnect ground cable first.
- The machine must not be used while charging the batteries.
- When using the AC power supply, ensure it is protected with a circuit breaker and residual current device.



Keep away from the machine if it contacts energized power lines. Personnel on the ground or in the platform must not touch or operate the machine until energized power lines are shut off.

- Do not operate the machine or charge the batteries in hazardous environment ( Section D 7 - Battery care and maintenance).

A - Foreword



Risk of electrification or electrocution :

- DC, for > 60 volts or a capacity > 180 A.h ;
- AC for > 25 volts .

Before any intervention on the electrical circuit, or for any work near a LIVE part, the machine must be locked out by an authorised and properly trained person.

After it is locked out, and before any intervention on the electrical power circuit, wait 5 minutes for the voltage to drop to 0 Volt. Using a voltage absence tester, make sure that the voltage is definitely at 0 Volt. MS0163 — Lock-out procedure.

Reminder of voltages and currents present on the machine :

- 12 volts DC / VDC(DC direct current version)
- 72 volts DC / VDC (DC direct current version)
- 53 volts AC / VAC(AC alternating current version)
- Capacities > 180 Ah (For example, 6 Volts - 357 Ah semi-traction batteries in C5 or 435 Ah in C20) :

N.B.-: National regulations may require training for operators for operations on the electrical parts.

Capacity in Amp Hours (Ah)

5 hours	10 hours	20 hours	100 hours
357	400	435	483

A - Foreword

2.1.5 - Explosion / Fire Hazards

- Always wear protective clothing and eye wear when working with batteries and power sources/systems.

N.B.-: Acid is neutralized with sodium bicarbonate and water.



Do not work on or operate a machine in an explosive or flammable atmosphere / environment.

- Do not touch hot components.
- Do not bridge the battery terminals with metallic objects.
- Do not service the battery in proximity of spark, open flame, lit cigarettes.
- Do not fill up the fuel tank, when the engine is running and/or near a flame.



2.1.6 - Crushing / Collision Hazards

- Warn personnel not to work, stand, or walk under a raised boom/platform.
- Be aware of the boom position and tail swing when rotating the turret (turntable).
- Always ensure that the chassis is never kept any closer than 1 m (3 ft 3 in) to holes, bumps, slopes, obstructions, debris and ground coverings that may hide holes and other dangers.
- Keep non-operating personnel at least 5 m (16 ft 5 in) away from the machine when driving and slewing.
- Be aware of driving direction.
 - When turret is slewed/rotated 180°, the platform is now facing the rear of the machine.
 - Check the driving direction with the help of the red or white arrows on the chassis and the platform control box.
 - Also note that when changing the driving direction (Forward <=> Reverse) the joysticks or switches must return to the neutral position before reversing the drive direction and for movement to occur.
- When driving, position the platform so as to provide the best possible visibility and to avoid any blind spots.
- Hold on securely to the guardrails.

A - Foreword

- Personal Protection Equipment (EPI) :
 - The occupants of the aerial work platform must wear personal protection equipment and comply with local regulations in force.
 - Operators must comply with the safety standards of the job site and the employer, as well as the applicable state regulations relating to the use of personal protective equipment.
 - All personal fall protection equipment (PFPE) must comply with current regulations, must be inspected and used in accordance with the manufacturer's instructions.
- Avoid contact with fixed or mobile obstacles (other machines).
- Other machines (crane, aerial work platform, etc.) operating in the work area increase the risk of crushing or collision. Restrict the operation of machines moving within the aerial work platform work area.
- Take into consideration the stopping distance, reduced visibility and blind spots of the machine.
- Limit travel speed to suit the ground surface condition, slope (incline), and people in the vicinity.

2.1.7 - Risk of involuntary movements

Never use a damaged or malfunctioning machine.

Always respect the following rules :

- Maintain clearance from high voltage lines.
- Maintain clearance from generators, radar, electromagnetic fields.
- Never expose the batteries or electrical components to water (high pressure washer, rain).

3 - Safety inquiries

Inquiries relating to design criteria/specifications of a product, standards compliance, or overall machine safety should be sent to the HAULOTTE® PRODUCT SAFETY department.

Each inquiry or request should include all relevant information; including contact name, telephone number, mailing address, email address, plus the machine model and serial number.

The HAULOTTE® Product Safety department will evaluate each request/inquiry and will provide a written response.

A - Foreword

4 - Incident notification

Notify HAULOTTE® immediately when a HAULOTTE® product has been involved in an incident/accident leading to personal injury or death, or when there is a major property damage.

<p>HAULOTTE Group - EUROPE Product Safety Department</p> <p>Address : Rue Emile Zola - 42420 Lorette - France</p> <p>Tel : +33 (0)4 77 29 24 24</p> <p>Email : productsafety.europe@haulotte.com</p>	<p>HAULOTTE Group - Australia, India and Asia Product Safety Department</p> <p>Address : No.26 Changi North Way - Singapore 498812 - Singapore</p> <p>Tel : +65 6546 0123</p> <p>Email : productysafety.apac@haulotte.com</p>	<p>HAULOTTE Group - North & South America Product Safety Department</p> <p>Address : 3409 Chandler Creek Rd. - Virginia Beach, VA 23453 - United States</p> <p>Tel : +1 757 689 2146</p> <p>Email : productsafety.americas@haulotte.com</p>
--	---	---

Connect to our website : www.haulotte.com



A - Foreword

5 - Compliance

5.1 - PRODUCT MODIFICATION

It is strictly forbidden to modify a HAULOTTE® product. Any modification may violate Haulotte design parameters, local regulations and industry standards.

Any requests for modification must be formulated in writing (form) and be approved by the manufacturer.

Do not hesitate to contact HAULOTTE Services®, should you have any questions relating to the issued bulletin(s) or with questions on the policy itself.

5.1.1 - Implementing manufacturer safety campaigns

It is essential to implement the safety campaigns issued by the manufacturer. All of these campaigns are accessible on our website.

Connect to our website : www.haulotte.com



Never market (or sell) a machine without first having carried out all of the safety campaigns.

5.2 - PRODUCT SPECIFICATIONS

HAULOTTE® cannot be held liable for any changes to the technical characteristics/specifications contained in this manual. HAULOTTE® has a continuous improvement policy in place for its product range. Given this policy, the Company reserves the right to modify products technical characteristics / specifications without notice.

A - Foreword

5.3 - CHANGE OF OWNERSHIP NOTIFICATION

It is important and necessary to keep HAULOTTE Services® updated with current ownership of the machine. This way, HAULOTTE® will be able to provide the necessary support for the product. If you have sold or transferred this machine(s); it is your responsibility to notify HAULOTTE Services®. It is not required to include Lessees/Renters of Leased/Rented machines on this form.

Connect to our website : www.haulotte.com



A - Foreword

5.4 - DECLARATION OF CONFORMITY



The CE declarations of conformity only apply to machines that have been approved and commissioned within the European Community (EC).

Declaration of conformity - Thermal platforms



DECLARATION CE DE CONFORMITE
(EC DECLARATION OF CONFORMITY)



<p>Fabricant et personne autorisée à constituer le dossier technique <i>(Manufacturer and the person authorised to compile the technical file:)</i></p> <p>HAULOTTE GROUP</p> <p>Adresse du site de production <i>(Address of the Division)</i></p> <p>en conformité avec le modèle type <i>(In compliance with the Model Type)</i></p> <p>Nom commercial <i>(Commercial name)</i></p> <p>Numéro de série <i>(Serial number)</i></p> <p>Organisme notifié <i>(Notified body)</i></p> <p>Numéro de certificat <i>(Certificate number)</i></p> <p>Charge maximale d'utilisation <i>(Rated capacity)</i></p>	<p>Compliance & Regulation Director HAULOTTE GROUP S.A. RUE EMILE ZOLA 42420 LORETTE FRANCE</p> <p>Nacelle élévatrice de personnel <i>(Mobile Elevating Work Platform)</i></p> <p>Modèle type de la machine concernée <i>(Type model of the concerned machine)</i></p> <p>Nom commercial de la machine concernée <i>(Commercial name of the concerned machine)</i></p> <p>Numéro de série de la machine concernée <i>(Serial number of the machine)</i></p> <p>Nom et adresse de l'organisme notifié <i>(Name and address of the notified body)</i></p> <p>Numéro de certificat du type de machine <i>(Certificate number of the type of machine)</i></p> <p>Charge maximale d'utilisation de la machine concernée <i>(Rated capacity of the concerned machine)</i></p>
--	---

Nous déclarons que cette machine est conforme aux dispositions des Directives suivantes
(We hereby declare that this machine conforms with all the relevant provisions of the Directives listed below)

Directive CE Machine <i>(EC Machinery Directive)</i>	2006/42/CE
Se conforme aux principales exigences de la norme harmonisée <i>(This machine also fulfils the principles of the harmonised standard)</i>	EN280:2013 + A1:2015
Directive CE concernant la compatibilité électromagnétique <i>(EC Directive on electromagnetic compatibility)</i>	2014/30/EU
Directive CE RED concernant les équipements radio-électriques (si la machine est équipée) <i>(RED EC Directive on radio-electrical equipment (if machine equipped))</i>	
Directive CE d'émission de bruit <i>(EC Outdoor Noise Directive)</i>	2000/14/EC
Méthode de mesure <i>(Measurement method)</i>	Annex III-B
Niveau de puissance acoustique garanti <i>(LWA, Guaranteed sound level)</i>	101 dB
Niveau de puissance acoustique mesuré max <i>(LWA, Maximum sound level)</i>	99 dB

Cette déclaration porte exclusivement sur la machine dans l'état où elle a été placée sur le marché
(This declaration relates exclusively to the machinery in the state in which it was placed on the market)

Toute modification de la machine décrite ci-dessus a pour effet d'invalider cette déclaration
(Any modification to the above described machine violates the validity of this declaration)

Nom et signature du Directeur du site de production <i>(Name and signature of the Division Director)</i>	Lieu <i>(Place)</i>
	Date <i>(Date)</i>

haulotte.com

A - Foreword



The UK declarations of conformity only apply to machines that have been approved and commissioned within the United Kingdom (UK).

Declaration of conformity - Thermal platforms



UKCA DECLARATION OF CONFORMITY

Manufacturer and the person authorised to compile the technical file:

HAULOTTE GROUP

France



Nathalie Reynolds
 General Manager UK and Ireland
 Haulotte UK Ltd

Unit 1 Gravelly Way, Four Ashes
 Wolverhampton, West Midlands WV10 7GW
 ENGLAND

Mobile Elevating Work Platform

In compliance with the Model Type

Commercial name

Serial number

Approved body

Certificate number

Rated Capacity

Model Type of the concerned machine

Commercial name of the concerned machine

Serial number of the machine

Rated capacity of the concerned machine

We hereby declare that this machine conforms with all the relevant provisions of the Regulations listed below

Supply of Machinery (safety)	2008
This machine also fulfils the principles of the designed standards	BS EN280 : 2013 + A1 : 2015
Electromagnetic compatibility	2016
Radio equipment (if machinery equipped)	2017
Noise emission in the environment for use outdoors	2001
Measurement method	
LWA, Guaranteed sound level	
LWA, Maximum sound level	

This declaration relates exclusively to the machinery in the state in which it was placed on the market

Any modification to the above described machine violates the validity of this declaration

Name and signature division director

Date and place

haulotte.com

A - Foreword

Declaration of conformity - Electric platforms

A

B

C

D

E

F

G

H

I

Haulotte

DECLARATION CE DE CONFORMITE (EC DECLARATION OF CONFORMITY)



Fabricant et personne autorisée à constituer le dossier technique :
(Manufacturer and the person authorised to compile the technical file)

Compliance & Regulation Director
HAULOTTE GROUP S.A.
RUE EMILE ZOLA

HAULOTTE GROUP

42420 LORETTE
FRANCE

Adresse du site de production
(Address of the Division)

Nacelle élévatrice de personnel
(Mobile Elevating Work Platform)

en conformité avec le modèle type
(In compliance with the Model Type)

Modèle type de la machine concernée
(Type model of the concerned machine)

Nom commercial
(Commercial name)

Nom commercial de la machine concernée
(Commercial name of the concerned machine)

Numéro de série
(Serial number)

Numéro de série de la machine concernée
(Serial number of the concerned machine)

Organisme notifié
(Notified body)

Nom et adresse de l'organisme notifié
(Name and address of the notified body)

Numéro de certificat
(Certificate number)

Numéro de certificat du type de machine
(Certificate number of the type of machine)

Charge maximale d'utilisation
(Rated capacity)

Charge maximale d'utilisation de la machine concernée
(Rated capacity of the concerned machine)

Nous déclarons que cette machine est conforme aux dispositions des Directives suivantes
(We hereby declare that this machine conforms with all the relevant provisions of the Directives listed below)

Directive CE Machine
(EC Machinery Directive)

2006/42/CE

Se conforme aux principales exigences de la norme harmonisée
(This machine also fulfils the principles of the harmonized standard)

EN280:2013 + A1:2015

Directive CE concernant la compatibilité électromagnétique
(EC Directive on electromagnetic compatibility)

2014/30/EU

Directive CE RED concernant les équipements radioélectriques (si machine équipée)
(RED EC Directive on radio electrical equipment (if machine equipped))

2014/53/UE

Cette déclaration porte exclusivement sur la machine dans l'état où elle a été placée sur le marché
(This declaration relates exclusively to the machinery in the state in which it was placed on the market)

Toute modification de la machine décrite ci-dessus a pour effet d'invalider cette déclaration
(Any modification to the above described machine violates the validity of this declaration)

Nom et signature du Directeur du site de production
(Name and signature of the Division Director)

Lieu (Place)

Date (Date)

B - Familiarization



UKCA Declarations of Conformity only apply to machines that are certified for England, Wales and Scotland.

Declaration of conformity - Electric platforms

Haulotte

UKCA DECLARATION OF CONFORMITY

UKCA

Manufacturer and the person authorised to compile the technical file:

HAULOTTE GROUP

France

Nathalie Reynolds
General Manager UK and Ireland
Haulotte UK Ltd

Unit 1 Gravelly Way, Four Ashes
Wolverhampton, West Midlands WV10 7GW
ENGLAND

Mobile Elevating Work Platform

In compliance with the Model Type

Commercial name

Serial number

Approved body

Certificate number

Rated Capacity

Model Type of the concerned machine

Commercial name of the concerned machine

Serial number of the machine

Rated capacity of the concerned machine

We hereby declare that this machine conforms with all the relevant provisions of the Regulations listed below

Supply of Machinery (safety)	2008
This machine also fulfils the principles of the designed standards	BS EN280 : 2013 + A1 : 2015
Electromagnetic compatibility	2016
Radio equipment (if machinery equipped)	2017

This declaration relates exclusively to the machinery in the state in which it was placed on the market

Any modification to the above described machine violates the validity of this declaration

Name and signature division director

Date and place

haulotte.com

B - Familiarization

1 - General safety

1.1 - INTENDED USE

Do not operate the product in the following situations :

- On soft, unstable or cluttered ground.
- With wind blowing faster than the permissible limit :
 - Check the allowable wind speed specified in the performance specifications tabulation.
 - Consult the Beaufort scale.
- Close to power lines. Keep a safe distance.
- If the machine is stored at a temperature out of range - 20°C / + 50°C (- 4°F / + 122°F).
- In an explosive atmosphere / environment.
- During storms.
- In the presence of strong electromagnetic fields.

N.B.:-Use the machine under "normal" climatic conditions. If you need to use the machine in climatic conditions likely to cause deterioration (extreme : humidity, temperatures, salinity, corrosiveness, atmospheric pressure), contact HAULOTTE Services®. Reduce intervals between servicing.

N.B.:-In harsh environments (high levels of salinity in the atmosphere: close to the sea, industrial environment with chloride emissions and/or humidity > 70%), we recommend applying solvent-based oil to the entire machine.

N.B.:-While the machine is not in use, care must be taken to bring the machine to the fully stowed position. Ensure that the machine is locked in a secure location, and the control key is removed to prevent unauthorised use of the machine.

1.2 - DECAL CONTENT

The purpose of the labels on the machine is to alert the user to the conditions of use and risks related to aerial work platforms.

Decals provide the following information :

- The level of severity.
- The specific hazard.
- A method to avoid, suppress or reduce the hazard.
- Descriptive text (where required).

Familiarize yourself with the decals and the hazard severity levels.

The labels must be kept in good condition, otherwise they must be replaced.

Familiarize yourself with the decals and their respective color codes.







Additional decals can be ordered from HAULOTTE Services®.

B - Familiarization

1.3 - SYMBOLS AND COLORS

Symbols and colors are used to alert the operator of safety precautions and/or to highlight important safety information.

The following safety symbols are used throughout this manual to indicate specific hazards and the hazard severity level when operating or maintaining the Aerial Work Platform.

Symbol	Description
	Danger : Risk of injury or death
	Caution : Risk of material damage
	Prohibited action
	Reminder to use good practice or follow pre-operation checks
	Cross-reference to another part of the manual
	Cross-reference to another manual
	Cross-reference to repair (contact HAULOTTE Services®)
N.B. :	Additional technical information

1.4 - LEVEL OF SEVERITY



































Color	Title	Description
	 DANGER	Danger : Indicates a hazardous situation which if not avoided, WILL result in death or serious injury.
	 WARNING	Warning : Indicates a hazardous situation which if not avoided, COULD result in death or serious injury.
	 CAUTION	Caution : Failure to comply could result in minor or moderate injury.
	 NOTICE	Notice : Indicates recommended practices if not followed, may result in a malfunction or damage the machine or its components.
	 PROCEDURE	Procedure : Indicates a maintenance operation.

B - Familiarization

1.5 - SYMBOLS LEGEND AND DEFINITIONS

Symbols are used throughout this manual to depict hazards, avoidance measures and indicate when information is required.

Refer to the following table to familiarize yourself with these symbols.

Symbol	Description	Symbol	Description	Symbol	Description
	Body crushing hazard		Foot crushing hazard		High pressure fluid ejection hazard
			Hand crushing hazard		Entanglement hazard
			Health/safety hazards related to chemicals		Health-damaging effects from hot work environment
	Electrical contact or lightning strike		Burns and scalds from contact with flames, explosion or radiation from heat sources		Injury from Electric arcs - Energy supply disconnecting devices - Batteries fire, emissions, etc
	Risk of operator(s) falling		Tip over due to excessive loading / wind load and excessive ground slope		Relate and coordinate directional arrows on the chassis with those on the control box
	Do not put foot in this area		Do not put your hand in this area		Keep away from product working area
	Never expose batteries and electrical component to high pressure washer		Ensure entry drop rail is down		Overload
	Flames prohibited		Maintain safe clearance from high voltage electrically charged conductors as described in manual - Do not use in thunderstorms		Refer to operator manual
	Safety belt		Use appropriate lanyard attached to dedicated anchor point.		Wheel pressure
	Enable switch		Use safety prop before attempting any maintenance work		Tow point
	Tie down point		Lift point		Keep away from hot surfaces
	Wear protective equipment		Recharge the batteries		

B - Familiarization

2 - Models description

Models	Regulations						
	CE	UKCA	ANSI	CSA	EAC	AS	JIS
HA20 LE	✓	✓	✗	✗	✓	✓	✓
HA20 LE PRO	✓	✓	✗	✗	✓	✓	✓
HA61 LE	✗	✗	✓	✓	✗	✗	✗
HA61 LE PRO	✗	✗	✓	✓	✗	✗	✗

Legend

✓	Available
✗	Not available

B - Familiarization



Notes

A

B

C

D

E

F

G

H

I

B - Familiarization

3 - Primary machine components

3.1 - LAYOUT

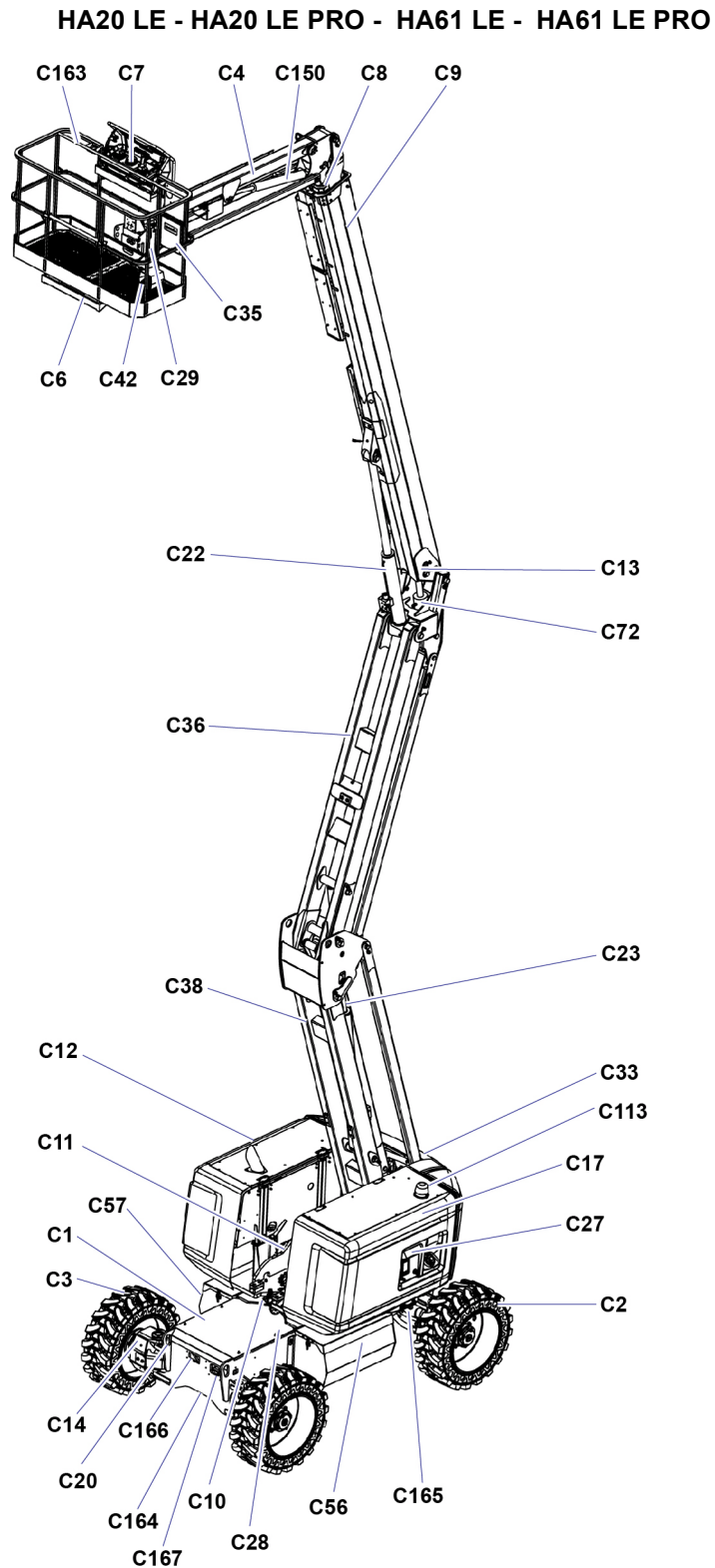

B - Familiarization

Marking	Description	Marking	Description
C1	Chassis	C28	Tilt sensor
C2	Steering wheel	C29	Platform rotation cylinder
C3	Rear drive wheel (and steer wheel if 4WS)	C33	Counterweight
C4	Jib	C35	Document holder
C6	Platform	C36	Top arm
C7	Platform control box	C38	Bottom arm
C8	Input jib leveling cylinder	C42	Foot Switch
C9	Upper boom	C56	Battery box - Right (12 6 V batteries)
C10	Slew ring	C57	Battery box - Left (12 6 V batteries)
C11	Turntable assembly	C72	Output jib compensation cylinder
C12	Left-side compartment (engine, starter battery and current generator)	C113	Beacon light
C13	Arm/Boom link piece	C150	Jib lifting cylinder
C14	Electric drive motor, reducer and break	C163	Hand (grab) rail
C17	Right compartment (hydraulic reservoir, motor pump unit)	C164	Non-steering fixed axle (For HA20 LE - HA61 LE only) Steering fixed axle (For HA20 LE PRO - HA61 LE PRO only)
C20	Tie-down (and/or lifting) points	C165	Oscillating steering axle (For HA20 LE - HA61 LE and HA20 LE PRO - HA61 LE PRO)
C22	Boom lift cylinder	C166	Battery charge indicator
C23	Arm lifting cylinder	C167	Battery charger
C27	Ground control box + Universal plug		

B - Familiarization

Universal plug connection

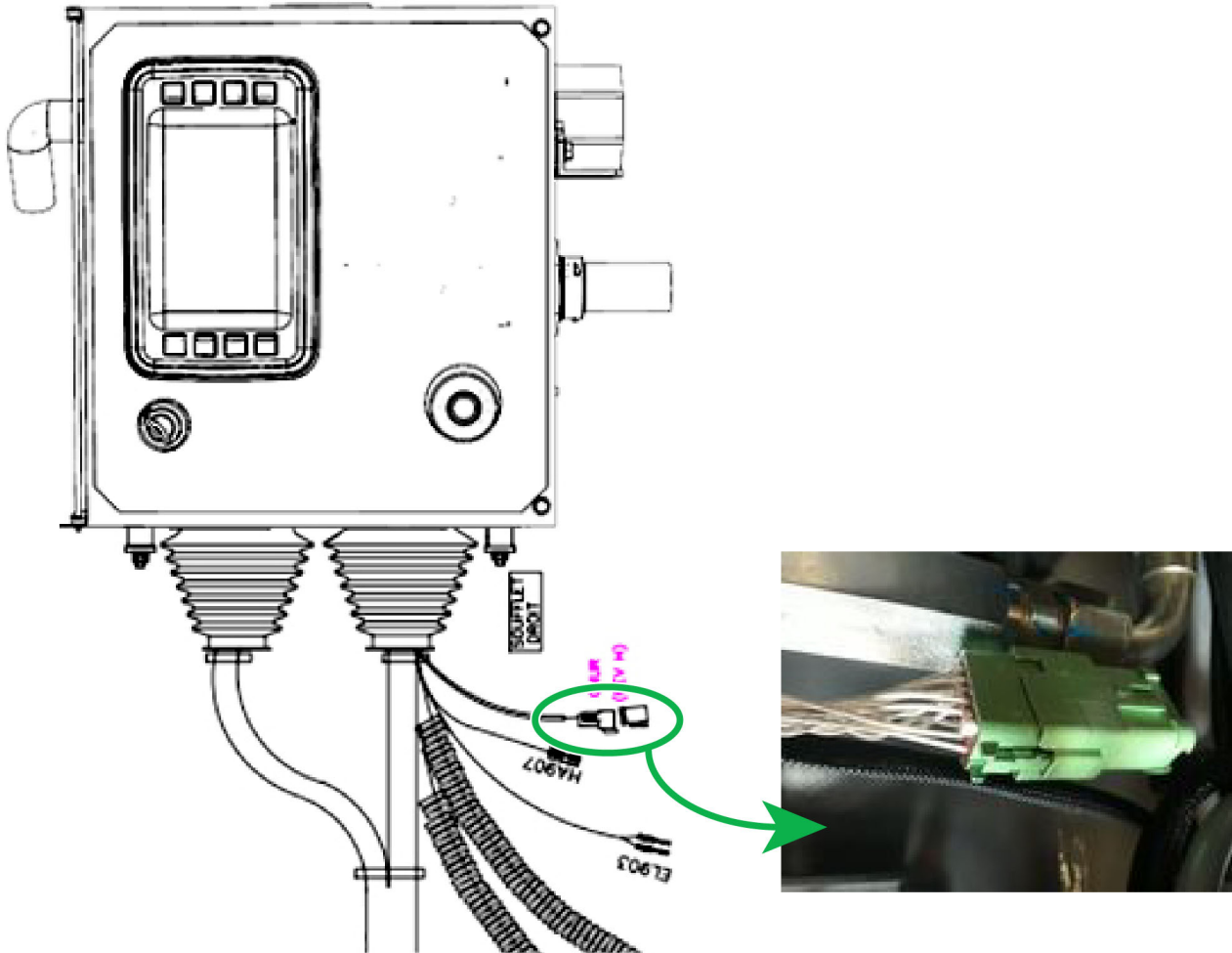

B - Familiarization



Notes

A

B

C

D

E

F

G

H

I

B - Familiarization

3.2 - GROUND CONTROL BOX















3.2.1 - Layout

General view















B - Familiarization



Controls and indicators

Marking	Name	Description	Function
1	SA720U	Platform tilt control	By pressing on  : Tilt the platform towards the front of the machine.
	SA720D		By pressing on  : Tilt the platform towards the back of the machine.
2	SA620U	Jib raising / lowering control	By pressing on  : Jib raising.
	SA620D		By pressing on  : Jib lowering.
3	SA530O	Boom telescoping switch	By pressing on  : Boom extending.
	SA530I		By pressing on  : Boom retracting.
4	SA520U	Boom raising / lowering control	By pressing on  : Boom raising.
	SA520D		By pressing on  : Boom lowering.
5	SA420U	Arm raising / lowering control	By pressing on  : Arm raising.
	SA420D		By pressing on  : Arm lowering.
6	SA905EN	Enable Switch	By pressing on Enable Switch  and simultaneously a desired function will activate a movement.
7	SA250L	Turntable rotation switch	By pressing on  : Counter clockwise (CCW) rotation.
	SA250R		By pressing on  : Clockwise (CW) rotation.
8	SA750L	Platform rotation switch	By pressing on  : Clockwise (CW) rotation.
	SA750R		By pressing on  : Counter clockwise (CCW) rotation.
9	SB801	E-stop button	Pulled out : Ground control box energized.
			Pushed in (activated) : De-energizes control system.

B - Familiarization

Marking	Name	Description	Function
10	HL905	Indicator, ground control box selected	LED lights up - ground control box icon.
11	SA801	"Overriding system" control	By pressing on  : Authorize movements from the ground control box in case of overload (Use ONLY in case of emergency)
12	SB907	Horn button	By pressing on  : Horn activation.
13	HL906	Indicator of the platform control box selection	LED lights up - platform control box icon.
14	SA903	Beacon light on/off	By pressing on  : Beacon light ON / OFF.
15	HL909	Overload indicator / Fault	<p>Alarm icon  :</p> <ul style="list-style-type: none"> • Overload icon (15) and Engine warning icon (16) are lit, when power is switched ON. • Overload icon will be blinking : • If there is a fault, an error code will be displayed on the Activ' Screen. • Or Hydraulic oil temperature icon is active on the Activ' Screen. • Or Engine pressure icon is active on the Activ' Screen. • Or Engine stop icon is active on the Activ' Screen. • Or Overload machine status is active on the Activ' Screen.
16	HL908	Engine warning indicator / Engine pre-heating	<p>Warning icon  :</p> <ul style="list-style-type: none"> • Overload icon (15) and Engine warning icon (16) are lit, when power is switched ON. • Engine warning icon will be blinking : • Engine warning icon will be displayed on the Activ' Screen. • Or Tilt machine status will be displayed on the Activ' Screen. • Or Engine is pre-heating.
17	SA310	Emergency back-up power	By pressing on  , when there is no normal power available, this switch works as an enable switch that must be pressed simultaneously with a desired function to activate movement.
18	SA308	Full Electric mode Refer to operator manual-  Section D 1.5 - Mode operation	In Full Electric mode, the combustion engine never starts. Energy comes from the batteries. This mode  is activated by default when starting the machine.
19	SA309	Auto mode Refer to operator manual-  Section D 1.5 - Mode operation	In Auto Mode  , the combustion engine starts and stops depending on the machine's use and traction battery charge level. The combustion engine recharges the batteries.
20	SA905ST	Manual mode (Forced charging) Refer to operator manual-  Section D 1.5 - Mode operation	In Manual Mode  , the user starts and stops the combustion engine. The combustion engine recharges the batteries. Above 95 %, the engine stops if no movement is initiated.

B - Familiarization

Marking	Name	Description	Function
21	—	Control box activation key switch	 : De-energizes control system.
	SA901PF		 : Platform control box energized.
	SA901TU		 : Ground control box energized.
22	—	Touch screen display	

A

B

C

D

E

F

G

H

I









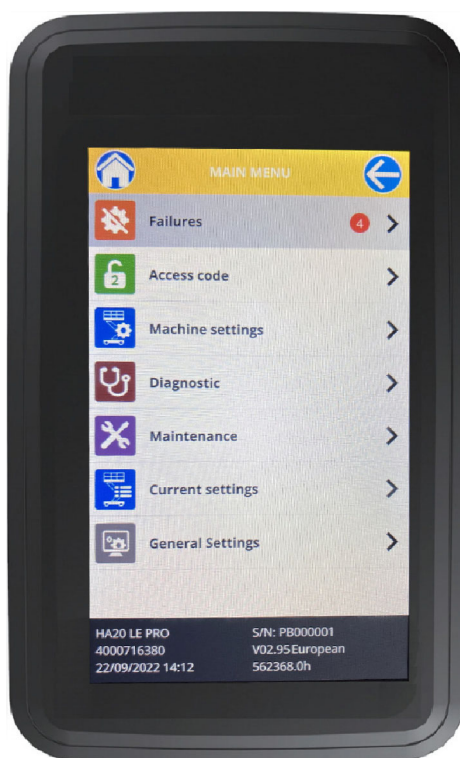

B - Familiarization

3.2.2 - Touch screen display

Upon starting and during operation of the machine, the touch screen display located on the ground control box displays in real time the machine operating status.

Touch screen display



	Home Button		Machine settings
	Back button		Diagnostic
	Access menu button		Maintenance
	Failures		Current settings
	Access code		General settings

N.B.: - Press your finger on the touch screen to navigate through the different menus. For example, press **CURRENT SETTINGS**, the following window will open

B - Familiarization

Navigation in the menus

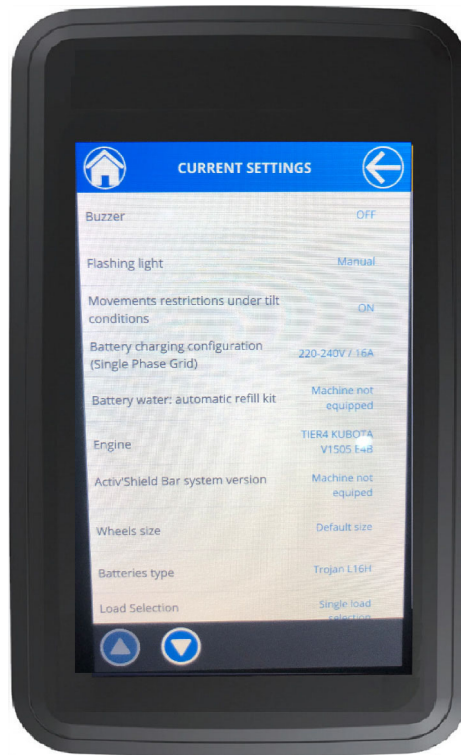

Scroll down screen button (Scrolling is possible by sliding your finger vertically on the screen)



Scroll up button (Scrolling is possible by sliding your finger vertically on the screen)

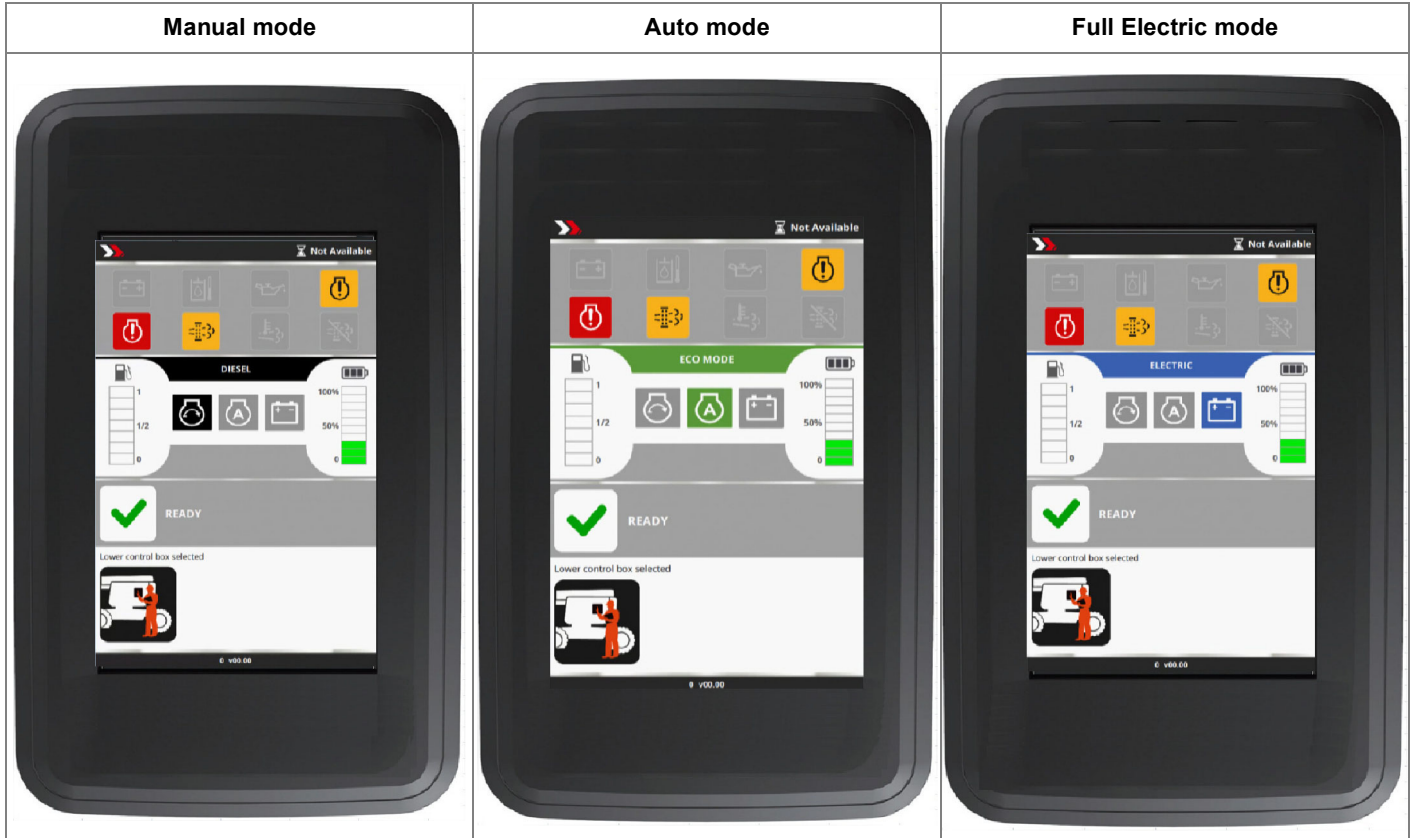

B - Familiarization

Touch screen display

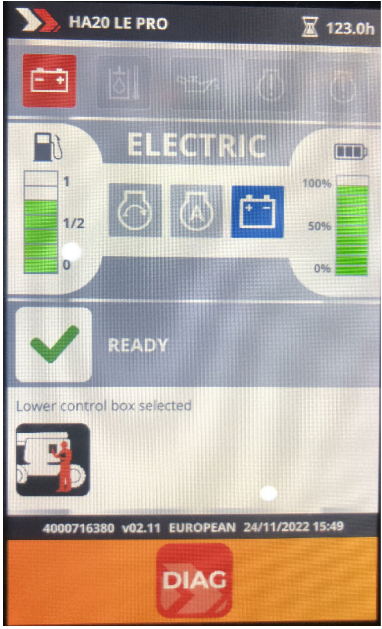
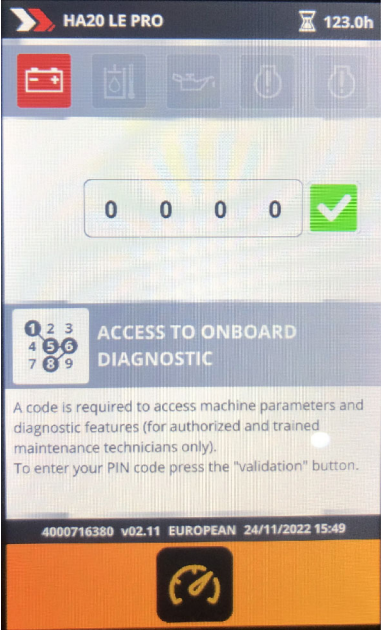

B - Familiarization

Controls and indicators

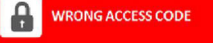
Icon	Icon	Icon	Description	Function
				<p>Press this icon to enter the diagnostic access code</p>
	<p>Access code (Will be visible - depending on the machine)</p>	  	<p>Access code not yet entered</p> <p>Access code entered is correct (Level 1, 2 or 3 depending on authorization of technician)</p> <p>Access code entered is incorrect</p>	





B - Familiarization

Controls and indicators

Icon		Icon	Description	Function
	<p>Enter access code (Will be visible - depending on the machine)</p>		<p>Enter the access code using the keypad (Press the touch screen)</p>	
 <p>Access code is requested to access machine parameter and diagnostic features (for authorized and trained maintenance technicians only). To enter your PIN code press the "validation" button.</p>	<p>Access code NIV 1 (Will be visible - depending on the machine)</p>	<p>The machine can be personalized with a user identification code. Personalization is only possible with NIV 1 : 1250 access. Machine properties display : Soft version, machine serial number, adjustment parameters. Possible change of parameters : Language, fault display format, brightness setting, time, and some options availables.</p>		
			<p>Operator PIN code not yet entered</p>	
			<p>Operator PIN code entered is correct</p>	
			<p>Operator PIN code entered is incorrect</p>	

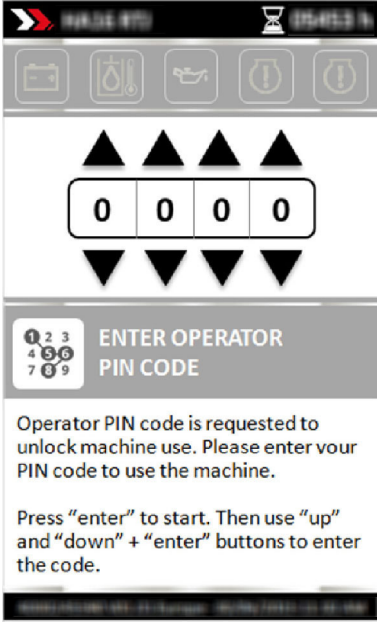

B - Familiarization

Controls and indicators

Icon	Function	Icon	Description
	<p>Operator PIN code (Will be visible - depending on the machine)</p>		<p>The machine can be personalized with a user identification code. Personalization is only possible with NIV 2 access. Contact HAULOTTE Services@.</p> <p>Operator PIN code not yet entered</p>
			<p>Operator PIN code entered is correct</p>
			<p>Operator PIN code entered is incorrect</p>

B - Familiarization

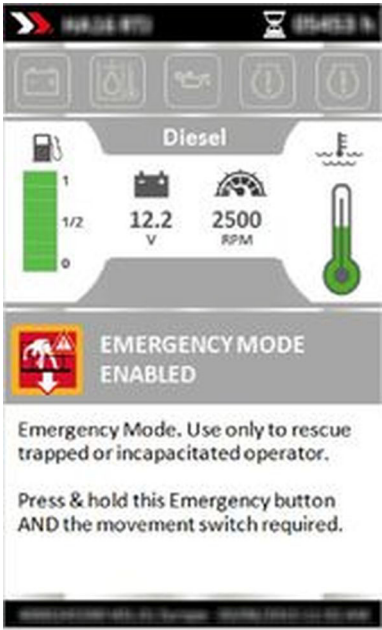
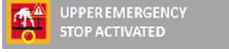
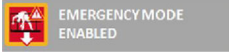
Controls and indicators

Icon	Description	Function	Icon	Description	Function
 <p>The screenshot shows a top status bar with 'HA20 LE PRO' and a battery icon. Below are icons for fuel, oil, and temperature. A 'Diesel' section shows a fuel gauge (0 to 1), a battery icon with '12.2 V', and a tachometer with '2500 RPM'. A large red warning box at the bottom says 'EMERGENCY MODE ENABLED' with a downward arrow icon. Below the warning, it reads: 'Emergency Mode. Use only to rescue trapped or incapacitated operator. Press & hold this Emergency button AND the movement switch required.'</p>		Platform control box E-stop button		E-Stop at platform control box has been pushed in (de-energized). The machine will switch off after several seconds. In an emergency, use this mode.	
		Emergency mode		<p>Emergency mode is activated when :</p> <ul style="list-style-type: none"> • The E-Stop at platform control box is pushed in (de-energized). • The machine is in overload state. • Ground control box is selected/energized. • The emergency overriding button is activated. 	
				<p>Emergency mode is deactivated when :</p> <ul style="list-style-type: none"> • The E-Stop at platform control box is pulled out (energized). • The machine is NOT in overload state. • Ground control box is NOT selected/energized. 	
				The Emergency mode is out of service/non-functional	

B - Familiarization

Controls and indicators

Icon	Description	Icon	Description	Function
------	-------------	------	-------------	----------



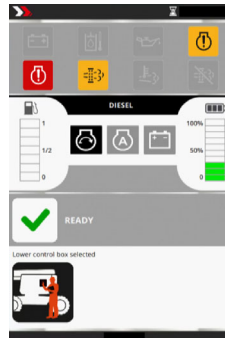

Home screen (dashboard)
(Will be visible - depending on the machine)



	<p>Machine model zone</p>		<p>Machine Model</p>	<p>Machine model display</p>
	<p>Hour meter/next maintenance zone</p>		<p>Hourmeter</p>	<p>The hourglass will flash if there is movement or motion of the machine. The hour meter increments. If the engine is running without any movement, the machine hour meter does not increment. Combustion engine maintenance is not managed by the hour meter. Refer to the Tool maintenance manual.</p>
			<p>Maintenance use</p>	<p>The Maintenance Tool icon and the number of hours remaining until the next maintenance are displayed for 5 seconds when the machine is started up. Maintenance Tool icon blinks; if maintenance is due.</p>
				<p>The maintenance tool icon turns RED when the next scheduled maintenance must be carried out in under 25 hours.</p>

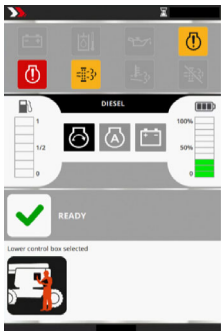

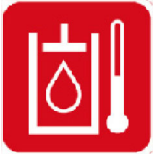
B - Familiarization

Controls and indicators

Icon	Description	Icon	Description	Function
Home screen (dashboard) (Will be visible - depending on the machine)				
				
	Warning icons zone		Battery State	<ul style="list-style-type: none"> • Icon is ON if there is no charge output detected from the alternator • Icon is flashing if a failure code for the alternator is detected (code F09.10)
			Hydraulic oil temperature	Icon is ON when the temperature in the hydraulic reservoir has exceeded the maximum required temperature. Stop using the machine and allow the oil to cool down.
			Engine oil pressure	Icon is ON if engine oil pressure is lower than required limit while engine is running. The Engine must be switched OFF immediately to avoid damaging the motor.
			Stop motor	<ul style="list-style-type: none"> • Icon is ON if an engine failure is detected (coolant, pressure, alternator etc) • Or if the Engine shuts down after 3 seconds of running. • Or after 1 second when engine fails to start.



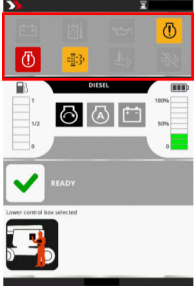



B - Familiarization

Controls and indicators

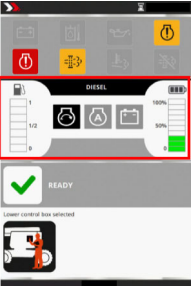
Icon	Description	Icon	Description	Function
Home screen (dashboard) (Will be visible - depending on the machine)				
	Warning icons zone		Engine warning	Icon is ON if Engine warning is detected. Or one of the engine maintenance schedules has been exceeded.
			Engine decontamination fault (If fitted)	Engine decontamination system fault. In this case, you must contact HAULOTTE Services® as soon as possible.



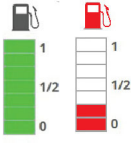
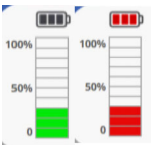
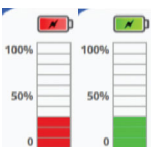

B - Familiarization

Controls and indicators

Icon	Description	Icon	Description	Function
Home screen (dashboard) (Will be visible - depending on the machine)				
	Functional information zone		Power mode used	• Diesel
				• ECO MODE
				• Electrical
			Bargraph	
	Functional information zone		Analog Gauge - Fuel level gauge	The fuel level indicator switches from GREEN to RED when the fuel level is low
			Analog Gauge - Battery charging indicator	The battery discharge indicator turns from GREEN to RED when the battery status is less than 20%
			Analog Gauge - Battery charging indicator	The battery charging indicator changes from RED to GREEN when the battery status is greater than 20%

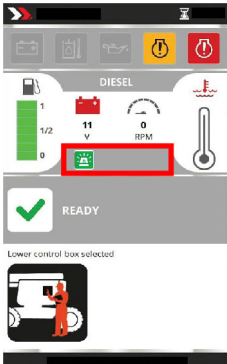

B - Familiarization

Controls and indicators

Icon	Description	Icon	Description	Function
Home screen (dashboard) (Will be visible - depending on the machine)				
			Additional functions	
			Beacon	The icon is ON when the flashing light is switched on
			Working light	The icon is ON when the work light is switched on
			Activ' Lighting System	The icon is ON when the Activ' Lighting System is switched on in auto or manual mode



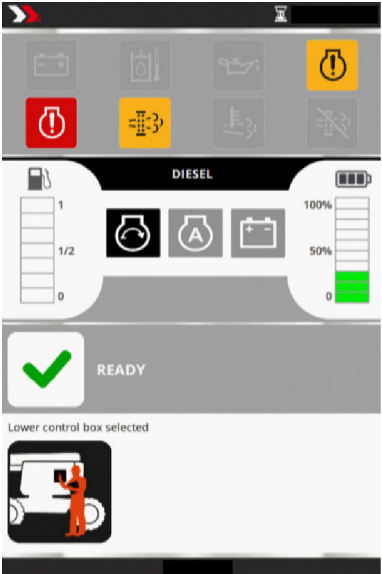
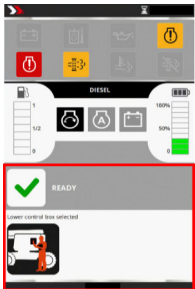
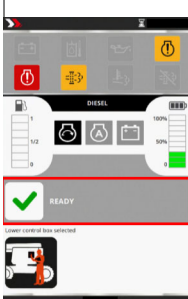

B - Familiarization

Controls and indicators

Icon	Function	Icon	Description	Function
Home screen (dashboard) (Will be visible - depending on the machine)				
				
	Machine status zone		Pictogram and title	Displays the pictogram and machine status
			Ready	Machine ready, displayed when no failures and no other machine state icons is active
			Alarm	Alarm icon is flashing slowly If there is either an active or detected machine failure, or if the machine is in an overload or tilt is active. When the Alarm symbol is displayed, there will also be a symbol displayed to show either the type of machine state, or machine failure that corresponds.

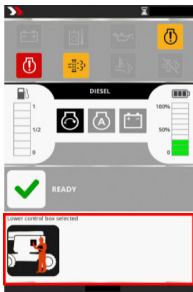
B - Familiarization

Controls and indicators

Icon	Description	Icon	Description	Function
Home screen (dashboard) (Will be visible - depending on the machine)				
				
		Platform control selected		Selector switch is in platform control box position
		Ground control selected		Selector switch is in ground control box position
		Tilt		The machine is elevated, and is on a slope greater than the permitted slope. Depending on the machine configuration, machine raise and extend functions may be slowed or prevented.
		Overload		The platform is overloaded. Remove the excessive load to or below the rated capacity, to restore functions. In case of an emergency, to rescue the operator in platform, use the Overriding system.

B - Familiarization

Controls and indicators

Icon	Description	Icon	Description	Function
------	-------------	------	-------------	----------

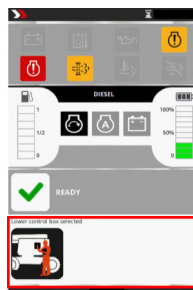

Home screen (dashboard)
(Will be visible - depending on the machine)



		Pre-heating	Engine's automatic preheat system is active. The time to pre-heat will vary according to engine and ambient temperature. Wait before starting the machine.
		Radius limitation	Icon is ON if the range limit is active.
		Movement restricted due to critical battery level	The battery level is critical. Battery recharge is mandatory.
		Machine is charging	The machine is recharged from the on-board generator.
		Board	Completely recharge the machine at least once every 7 days with the mains charger in order to optimize battery life (charging must start when the charge level is below 90 % to be effective).
		High temperature	Machine performance is limited due to the temperature being too high (drive engine, generator, pump motor, variable speed drive, etc.).

B - Familiarization

Controls and indicators

Icon	Description	Icon	Description	Function
Home screen (dashboard) (Will be visible - depending on the machine)				
			Low fuel level	The fuel level is on reserve level. Refill the fuel tank to the marked level. Attention: Lack of fuel may damage the motor/engine and will not be covered under warranty.
			Activ' Lighting System	The function is off. To switch it on, go to the 'Settings' menu

A

B

C

D

E

F



G

H

I



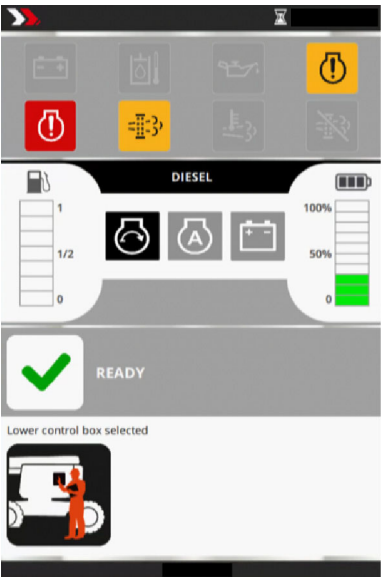

B - Familiarization

Controls and indicators

Icon	Description	Icon	Description	Function
Home screen (dashboard) (Will be visible - depending on the machine)				
				
			Diagnostic in progress	The HaulotteDiag console is connected to the machine
			Screen software obsolete	Screen software update essential Contact HAULOTTE Services®

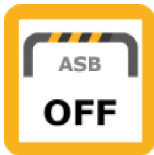
B - Familiarization

Controls and indicators

Icon	Description	Icon	Description	Function
Home screen (dashboard) (Will be visible - depending on the machine)				
		F12.01 bus CAN fault		CAN network fault between the screen and the rest of the machine
		Activ' Shield Bar disable		The secondary safety system is switched off
		Activ' Shield Bar triggered		<p></p> <p>The secondary safety system is triggered. An operator may be trapped on the platform :</p> <ul style="list-style-type: none"> • In this situation, supervisor(s) at ground level must turn the control box key selector (21) to the ground <p>control box  position to take control.</p> <ul style="list-style-type: none"> • The platform box controls are now de-energized. • Check that the E-Stop button (9) at ground is not pressed in. • To safely activate movements from the ground control box, the Enable <p>Switch (6)  must be pressed and held.</p>

A

B

C

D

E

F

G

H

I



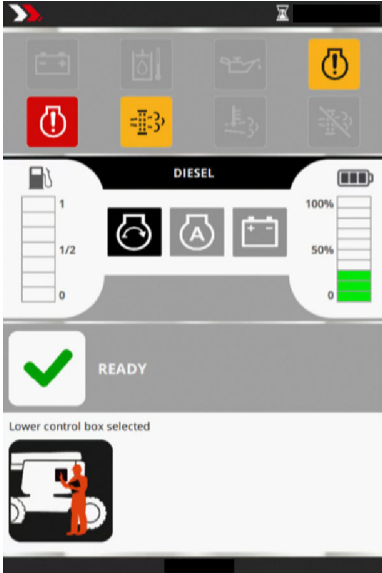
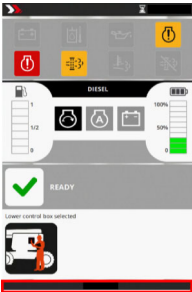
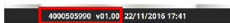
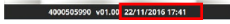

B - Familiarization

Controls and indicators

Icon	Description	Icon	Description	Function
Home screen (dashboard) (Will be visible - depending on the machine)				
				
	General information zone		Machine software version and code	Displays the reference and version of the software installed on the machine
			Machine date and time	Displays the date and time of the machine ECU

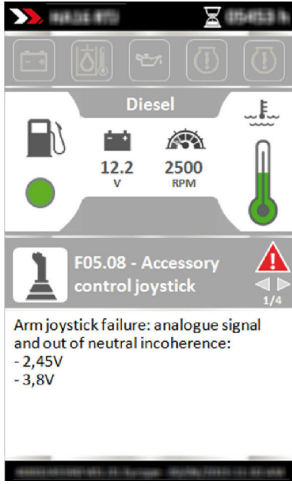
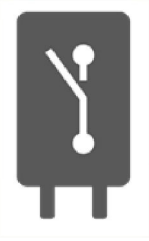

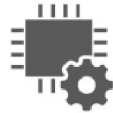

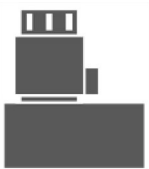
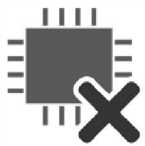



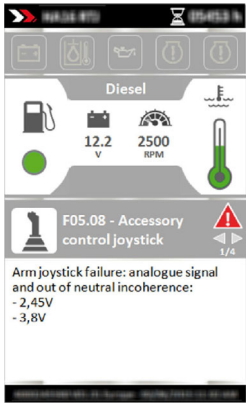

B - Familiarization

Controls and indicators

Icon	Description	Function	Icon	Description	Function
Machine fault (Will be visible - depending on the machine)					
					
Machine fault icons					
	Failure code F02.xx	Fault - power contactor		Failure code F09.xx	Fault - IC Engine
				Failure code F10.xx	Fault - Functions
	Failure code F03.xx	Fault - command relay		Failure code F11.xx	Fault - machine safety
	Failure code F04.xx	Fault - electrovalve		Failure code F12.xx	Fault - electronic control unit ECU

B - Familiarization

Controls and indicators

Icon	Description	Function	Icon	Description	Function
Machine fault (Will be visible - depending on the machine)					
					
Machine fault icons					
	Failure code F05.xx	Fault - joystick		Failure code F14.xx	Fault - Driving pump
	Failure code F06.xx	Fault - weight management system		Failure code F15.xx	Fault - data communication system CAN
	Failure code F07.xx	Fault - limit switch or sensor		Failure code F16.xx	Fault - Drive motors
	Failure code F08.xx	Fault - electrical circuit		Failure code F17.xx	Fault - Pump motor
	Failure code F13.xx	Fault - Switches		Failure code F18.xx	Fault - Generator motor

B - Familiarization

Controls and indicators

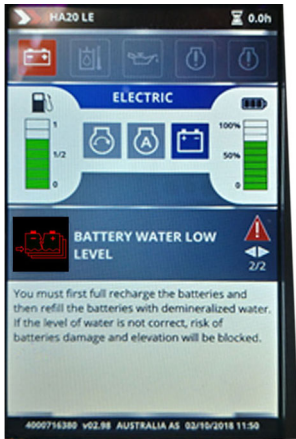
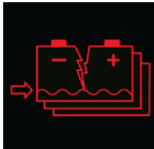
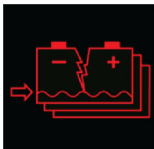
Icon	Icon	Description	Function
Filling if battery level alarm (Without automatic centralised filling option)			
<p>If "low water level" battery sensor is active</p> 		With "Battery saving" activation	<p>Low battery water level :</p> <ul style="list-style-type: none"> • You must first fully recharge the batteries and then refill the batteries with demineralized water • When the water level is low, high risk of batteries damage, so elevation will be blocked
		Without "Battery saving" activation	<p>Low battery water level :</p> <ul style="list-style-type: none"> • You must first fully recharge the batteries and then refill the batteries with demineralized water • When the water level is low, high risk of batteries damage

A

B

C

D

E

F

G

H

I

B - Familiarization

Controls and indicators

Icon	Icon	Description	Function
Filling if battery level alarm (With automatic centralized filling option)			
<p>If low water level tank sensor is active</p>		<p>Low Water level tank :</p> <ul style="list-style-type: none"> • Refill the water battery tank with demineralized water 	
<p>If "low water level" battery sensor is active</p>		<p>With "Battery saving" activation</p>	<p>Low battery water level :</p> <ul style="list-style-type: none"> • You must first refill the tank with demineralized water and then make a full recharge. • If the level of water is not correct, risk of damage the battery. Elevation will be blocked.
		<p>Without "Battery saving" activation</p>	<p>Low battery water level :</p> <ul style="list-style-type: none"> • You must first refill the tank with demineralized water and then make a full recharge. • If the level of water is not correct, risk of damage the battery.



B - Familiarization

Controls and indicators

Icon	Function	Description	Function
A full charge every 45 hours With "Battery saving" activation			
	35 hours without full recharge	Battery recharge	Warning next recharge must be a full recharge by plugging the machine electrical socket to external source of power to prevent damage on the batteries
	43 hours without full recharge		Warning next recharge must be a full recharge by plugging the machine electrical socket to external source of power. If not, risk of damage on the batteries and the machine will be blocked.
	45 hours without full recharge		Machine elevation blocked. You must full recharge by plugging the machine electrical socket to external source of power. Risk of damage on the batteries.

B - Familiarization

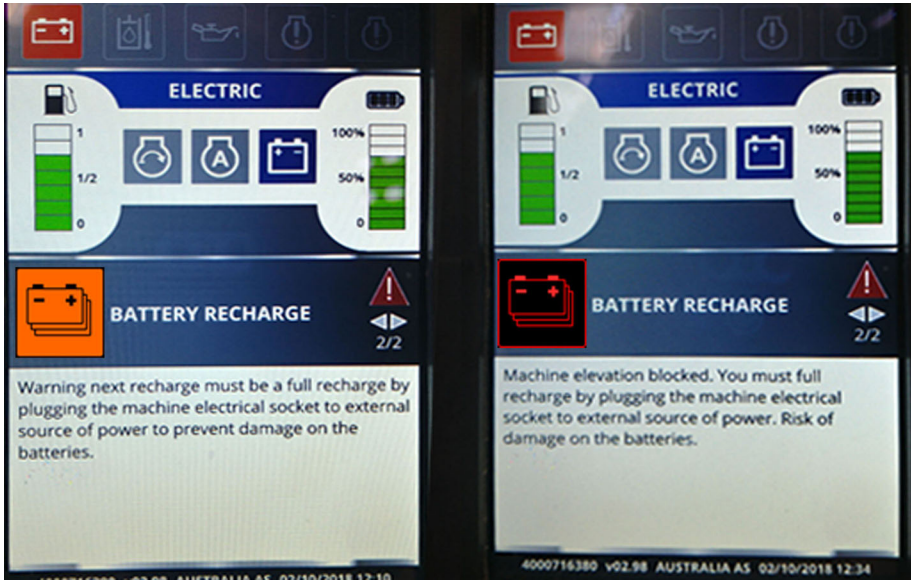
Controls and indicators

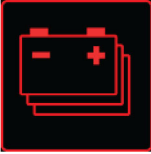
Icon	Function	Description	Function
<p>A full charge every 45 hours Without "Battery saving" activation</p> 			
	35 hours without full recharge	Battery recharge	Warning next recharge must be a full recharge by plugging the machine electrical socket to external source of power to prevent damage on the batteries.
	45 hours without full recharge		You must full recharge by plugging the machine electrical socket to external source of power. Risk of damage on the batteries.

B - Familiarization

3.3 - PLATFORM CONTROL BOX



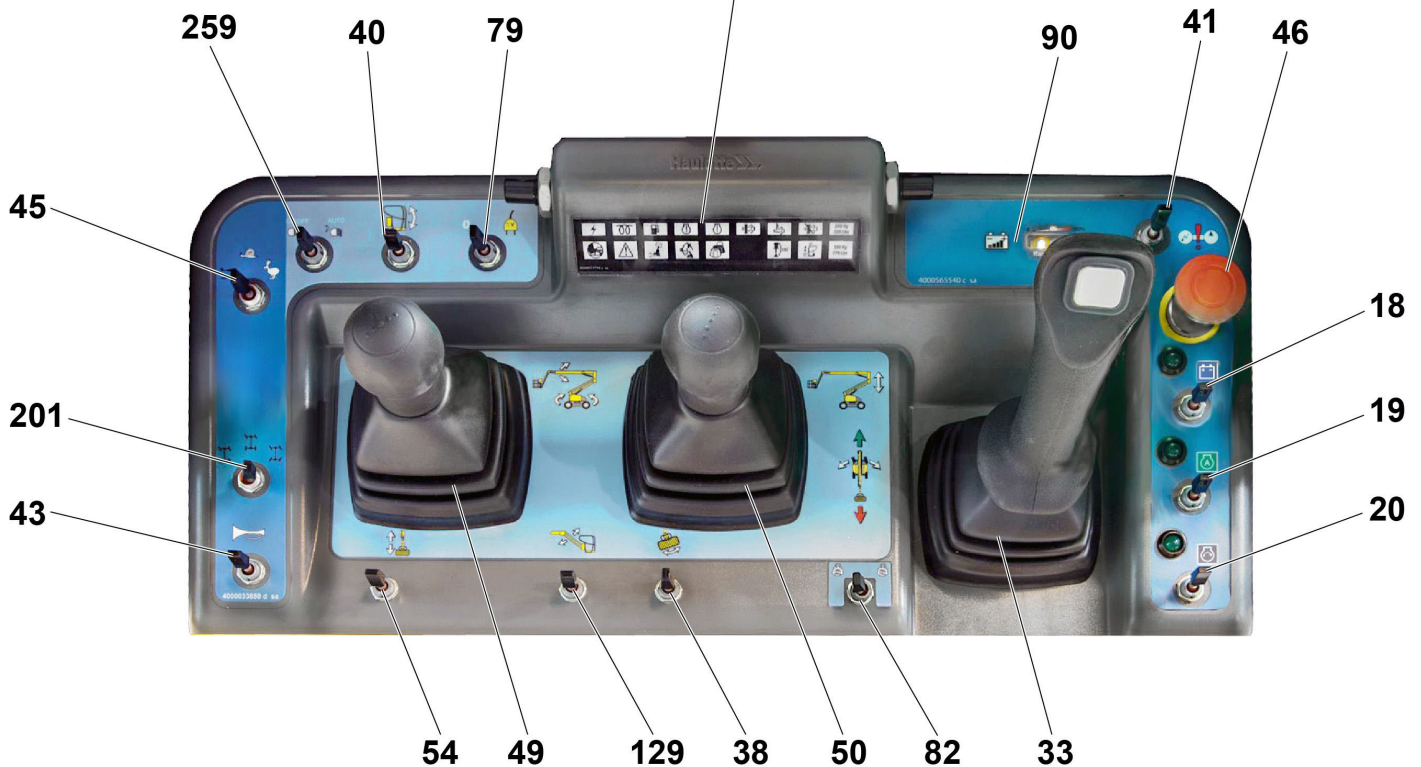

3.3.1 - Layout

General view





Affichage pupitre de commandes haut (LEDs 101 - 117)
Platform control box display (LEDs 101 - 117)





Controls and indicators

Marking	Name	Description	Function
18	SA306	Full Electric mode Refer to operator manual-  Section D 1. 5 - Mode operation	In Full Electric mode, the combustion engine never starts. Energy comes from the batteries. This mode  is activated by default when starting the machine.
19	SA307	Auto mode Refer to operator manual-  Section D 1. 5 - Mode operation	In Auto Mode  , the combustion engine starts and stops depending on the machine's use and traction battery charge level. The combustion engine recharges the batteries.

B - Familiarization

Marking	Name	Description	Function
20	SA303	Manual mode(Forced charging) Refer to operator manual-  Section D 1.5 - Mode operation	In Manual Mode  , the user starts and stops the combustion engine. The combustion engine recharges the batteries. Above 95 %, the engine stops if no movement is initiated.
33	SM902F	Drive joystick	Move forward : Forward drive
	SM902B		Move backwards : Reverse drive
	SM902R	Steering rocker switch	Press right side of button : Steer right - According to selected mode (201)
	SM902L		Press left side of button : Steer left - According to selected mode (201)
38	SA751R	Platform rotation switch	Move to the right : Counter clockwise (CCW) rotation
	SA751L		Move to the left : Clockwise (CW) rotation
40	SA721U	Platform leveling switch	Move upwards : Raise platform
	SA721D		Move downwards : Platform lowers
41	SA800	Auxiliary power supply control	Toggle and hold : Back-up unit activated
			Release : Back-up unit deactivated
43	SA907	Horn button	Push the horn selector to the right to sound the horn
			The horn stops when the selector switch is released
45	SA110HS	Drive speed selector	 High-speed drive
	SA110MS		 Medium speed drive
	SA110LS		 Going up and down a ramp
46	SB802	E-stop button	Pulled out : Platform control box energized
			Pressed in : De-energizes control system (Engine stopped)
49	SM900X	Turntable rotation joystick	Move to the right : Counter clockwise (CCW) rotation
	SM900N		Move to the left : Clockwise (CW) rotation
	SM900Y	Boom lift joystick	Move forward : Raise boom
	SM900N		Move backwards : Lower boom
50	SM901Y	Arm lift joystick	Move forward : Arm raises
	SM901N		Move backwards : Arm lowers
54	SA531I	Boom telescoping switch	Move upwards : Boom retracts
	SA531O		Move downwards : Boom extends

B - Familiarization

Marking	Name	Description	Function
79	SA906L	Generator selector ⁽¹⁾	Move to the left : Generator deactivated
	SA906R		Move to the right : Generator activated
82 ⁽²⁾	SA802	250 kg (550 lbs) or 350 kg (770 lbs) load selector	Move to the left : 250 kg (550 lbs) load selected
<div style="display: flex; gap: 10px;"> <div style="border: 1px solid black; padding: 2px;">250 Kg 550 Lbs</div> <div style="border: 1px solid black; padding: 2px;">350 Kg 770 Lbs</div> </div>			Move to the right : 350 kg (770 lbs) load selected
90	LBB02	Battery charging indicator	<p>Battery charge status.</p> <p>After 45 hours of use without recharging, the last digit of the bargraph will flash red whatever the charge status of the battery</p> <p>On the screen Activ'Screen of the ground control box, the current charge status of the battery will be displayed as well as the message that recharging is complete after 45 hours</p>
129	SA621U	Jib raising / lowering control ⁽³⁾	Hold upwards : Jib raise
	SA621D		Move downwards and hold : Lower jib
201	SA101_2 WS	Steering mode selector ⁽⁴⁾	Front 2 wheels steer
	SA101SY		All 4 wheels steer - Synchronized axle - Only for PRO model
	SA101CR		Crab steering - Only for PRO model
259	SA910_ONOFF	Activ' Lighting System selector	 ON / OFF
	SA910_AUTOTO		 Automatic lighting

- (1.) For machines fitted with
 (2.) If machine equipped with dual load
 (3.) For machines fitted with
 (4.) For machines fitted with

B - Familiarization

3.3.1.1 - Battery charging indicator (90)

Battery charge status

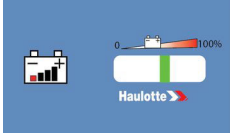
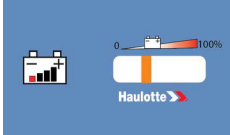
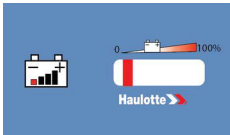
Icon	Function
	From 100% to 50%, the LED is green with the battery charge level displayed
	From 50% to 20%, the LED is orange with the battery charge level displayed
	<ul style="list-style-type: none"> From 10% to 20%, the second LED is red with the battery charge level displayed From 0% to 10%, the first 2 LEDs are alternately red with the battery charge level displayed



After 45 hours of machine movement without fully recharging the batteries and whatever the battery charge status, the first 2 LEDs are alternately red with the battery charge level displayed

B - Familiarization





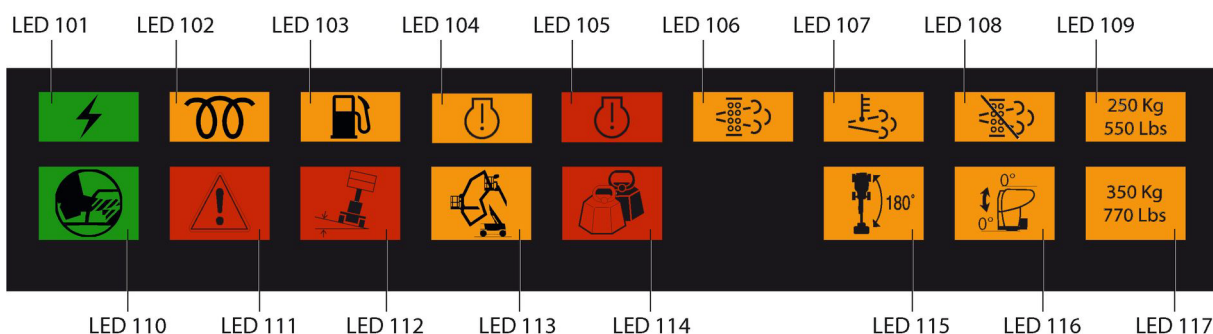

3.3.2 - Display Panel (LED'S 101 - 117)

Upper control box display



Marking	Name	Symbol	Function
LED 101	HL900		Machine switched on : <ul style="list-style-type: none"> • Rapid flashing : Machine is ON, but platform control box is not active but the ground control box is ON • Illuminated : Machine is turned on and platform control panel is active
LED 102	HL300		Combustion engine pre-heating : <ul style="list-style-type: none"> • Illuminated while engine is pre-heating • Off if engine started and if post-heating
LED 103	HL307		Low fuel level
LED 104	HL304		Engine warning : <ul style="list-style-type: none"> • Lighted in case of minor engine fault (e.g. water in the diesel, clogged air filter, etc.) • Lighted or flashing in case of fault managed by the engine ECU
LED 105	HL305		Engine shutdown : <ul style="list-style-type: none"> • Lighted in case of major engine fault (e.g. engine overheating, oil pressure, alternator fault, etc.) • Lighted in case of faults managed by the engine ECU
LED 106	HL301		DPF regeneration required (If equipped)
LED 107	HL302		DPF regeneration in progress, high temperature in the exhaust system (HEST) (If equipped)
LED 108	HL303		DPF regeneration inhibited (If equipped)
LED 109 ⁽¹⁾	HL805	250 Kg 500 Lbs	Load selection 250 kg (550 lbs) <ul style="list-style-type: none"> • 250 kg (550 lbs) load selected : LED 109 will be lit on display panel.
LED 110	HL807		Foot Switch : <ul style="list-style-type: none"> • Illuminated when Foot Switch activated • Blinks after 90 s of inactivity (in Manual Mode)
LED 111	HL801		Faults : <ul style="list-style-type: none"> • Rapid flashing : If a fault is active (current fault)

B - Familiarization

Marking	Name	Symbol	Function
LED 112	HL800		Tilt sensor : <ul style="list-style-type: none"> • Illuminated when in tilt, machine stowed or unfolded
LED 113	HL804		Radius limitation : <ul style="list-style-type: none"> • Rapid flashing : Reach limitation system fault • Slow flashing : The machine is in the 250 kg (550 lbs) low load zone, the low load is validated and 350 kg (770 lbs) heavy load is selected by the selector (82) • Illuminated : Limit of work zone with movement cut-off or machine in 250 kg (550 lbs) low load zone and load not validated
LED 114	HL802		Overload : <ul style="list-style-type: none"> • Rapid flashing : Faulty weighing / overload system • Illuminated when overloaded
LED 115	HL250		Not used
LED 116	HL720		Platform leveling +/- 10° : <ul style="list-style-type: none"> • Illuminated if the angle of the platform reaches +/- 10° in relation to the horizontal and movement control
LED 117 ⁽²⁾	HL806		<ul style="list-style-type: none"> • 350 kg (770 lbs) load selected : LED 117 will be permanently lit on display panel when the platform is positioned within the restricted working envelope. When the platform arrives in the upper limit of the restricted working envelope, the LED 117 will lit and the LED 109 will blink, with the possibility to switch to 250 kg (550 lbs) load selected if there is less than 250 kg (550 lbs) load in the basket. ⁽³⁾

(1.) If machine equipped with dual load

(2.) If machine equipped with dual load

(3.) If machine equipped with dual load

B - Familiarization

4 - Performance Specifications

4.1 - TECHNICAL CHARACTERISTICS

Use the table to select the right Haulotte machine for the job.



Do not replace parts that are essential to the stability of the machine, such as batteries or tyres, with parts that have a different weight or different specifications. The stability of the machine could be affected.

CE, UKCA, AS, EAC, CSA and ANSI A92.20 standards

Machine	HA20 LE - HA61 LE		HA20 LE PRO - HA61 LE PRO	
	SI	Imp.	SI	Imp.
Characteristics - Dimensions				
Maximum working height	20,70 m	67 ft 10 in	20,70 m	67 ft 10 in
Maximum platform height	18,60 m	61 ft	18,60 m	61 ft
Maximum horizontal reach 250 kg - 550 lbs	11,91 m	39 ft 1 in	11,91 m	39 ft 1 in
Maximum horizontal reach 350 kg - 770 lbs	9,91 m	32 ft 6 in	9,91 m	32 ft 6 in
Maximum outreach above the ground 250 kg - 550 lbs	11,40 m	37 ft 5 in	11,40 m	37 ft 5 in
Maximum outreach above the ground 350 kg - 770 lbs	9,40 m	30 ft 10 in	9,40 m	30 ft 10 in
Maximum platform height before driving speed restriction	6 m	19 ft 8 in	6 m	19 ft 8 in
Maximum boom articulation point height	8,50 m	27 ft 10 in	8,50 m	27 ft 10 in
Maximum load capacity	250 kg	550 lbs	250 kg	550 lbs
Maximum load capacity - Dual load	350 kg	770 lbs	350 kg	770 lbs
Jib working range	134° (+60° / -80°)			
Basket rotation angle	180° (+ 90° / -90°)			
Boom rotation angle	73°			
Turntable rotation	355° non continuous		360° Continuous	
Maximum number of occupants	2			
Maximum wind speed	45 km/h (12,5 m/s)	28 mph (41 ft/s)	45 km/h (12,5 m/s)	28 mph (41 ft/s)
Gradeability	45%			
Sideslope	25%			
Maximum rated slope allowed	4°			
Maximum slope in high speed downhill	25%			
Manual force	400 N - 90 lbf			
Maximum load on wheel	5050 kg	11,130 lbs	5050 kg	11,130 lbs
Outside turning radius - 4WS	NA	NA	3,75 m	12 ft 4 in
Outside turning radius - 2WS	4,50 m	14 ft 9 in	4,50 m	14 ft 9 in
Inside turning radius - 4WS	NA	NA	2 m	6 ft 7 in
Inside turning radius - 2WS	2,40 m	7 ft 10 in	2,40 m	7 ft 10 in
Maximum ground pressure of wheel on paved ground ⁽¹⁾	13,2 kgf/cm ²	187 psi	13,2 kgf/cm ²	187 psi
Total weight	9380 kg	20,680 lbs	9680 kg	21,340 lbs
Drive speed (4WS) :				
• Micro speed (Machine elevated)			0,7 km/h	0.45 mph
• Slow speed (Machine folded/stowed)	NA	NA	1,3 km/h	0.80 mph
• Medium speed (Machine folded/stowed)			3,9 km/h	2.45 mph
• High speed (Machine folded/stowed)			5 km/h	3.10 mph
Drive speed (2WS) :				
• Micro speed (Machine elevated)	0,7 km/h	0.45 mph	0,7 km/h	0.45 mph
• Slow speed (Machine folded/stowed)	1,3 km/h	0.80 mph	1,3 km/h	0.80 mph
• Medium speed (Machine folded/stowed)	3,9 km/h	2.45 mph	3,9 km/h	2.45 mph
• High speed (Machine folded/stowed)	5 km/h	3.10 mph	5 km/h	3.10 mph
Maximum freewheel speed during towed operation	5,0 km/h	3.10 mph	5,0 km/h	3.10 mph
Specifications - Performance				
Operating temperature	- 15° C / + 35° C (+ 5° F / + 95° F)			

B - Familiarization

Machine	HA20 LE - HA61 LE		HA20 LE PRO - HA61 LE PRO	
Operating temperature	- 30° C / + 50° C (- 22° F / + 122° F)			
For EAC only - If machine equipped with the option				
Storage temperature	- 20° C / + 50° C (- 4° F / + 122° F)			
Energy storage				
Starter battery type	12V 100A.h 800A			
Starting battery amperage	800A			
Starter battery voltage	12V			
Traction battery type	12x6V - 435A.h (C20)			
Traction battery voltage pack	72V			
Hydraulic tank capacity	140 L	37 gal US	140 L	37 gal US
Fuel tank capacity	80 L	21 gal US	80 L	21 gal US

(1.) The pressure values are given for standard machines without Option

A

B

C

D

E

F

G

H

I

B - Familiarization

4.2 - ENGINE SPECIFICATIONS

4.2.1 - Kubota engines

Engine - Tier IV Final / Stage V / China IV	
Engine type	Kubota V1505
Engine power	18,5 kW - 25 hp
CO emission	1,4 g/kWh
HC + NO emission	5,8 g/kWh
Particles emission	0,20 g/kWh
Av fuel consumption ⁽¹⁾	2,2 l/h - 0.60 gal/h
Fuel type	Diesel

(1.) Estimated consumption

Engine - Gas only ⁽¹⁾	
Engine type	Kubota WG 1605 - LE3
CO emission	5,3 g/kWh
HC + NO emission	0,3 g/kWh
Fuel type	GPL

(1.) For the US market only

For China only :

HA20 LE - HA20 LE PRO - Kubota Engine

环保信息标签	
达到 GB 20891-2014 第三阶段排放标准	
生产日期: AA	
环保信息公开编号: AB	
基本信息	型号: AC
	名称: 高空作业平台
	商标: 
	机械类型: 工程机械
	机械生产企业名称: 欧胜高空升降平台设备制造(常州)有限公司
机械进口企业名称: 欧历胜贸易(上海)有限公司	
发动机型号: AF	燃料喷射系统形式: 泵喷嘴
发动机生产厂家名称: 久保田	
环保关键零部件	ECU, 喷油泵, 喷油器, 排气消声器

B - Familiarization

4.3 - WORKING AREA / RANGE OF MOTION

HA20 LE - HA20 LE PRO - HA61 LE - HA61 LE PRO

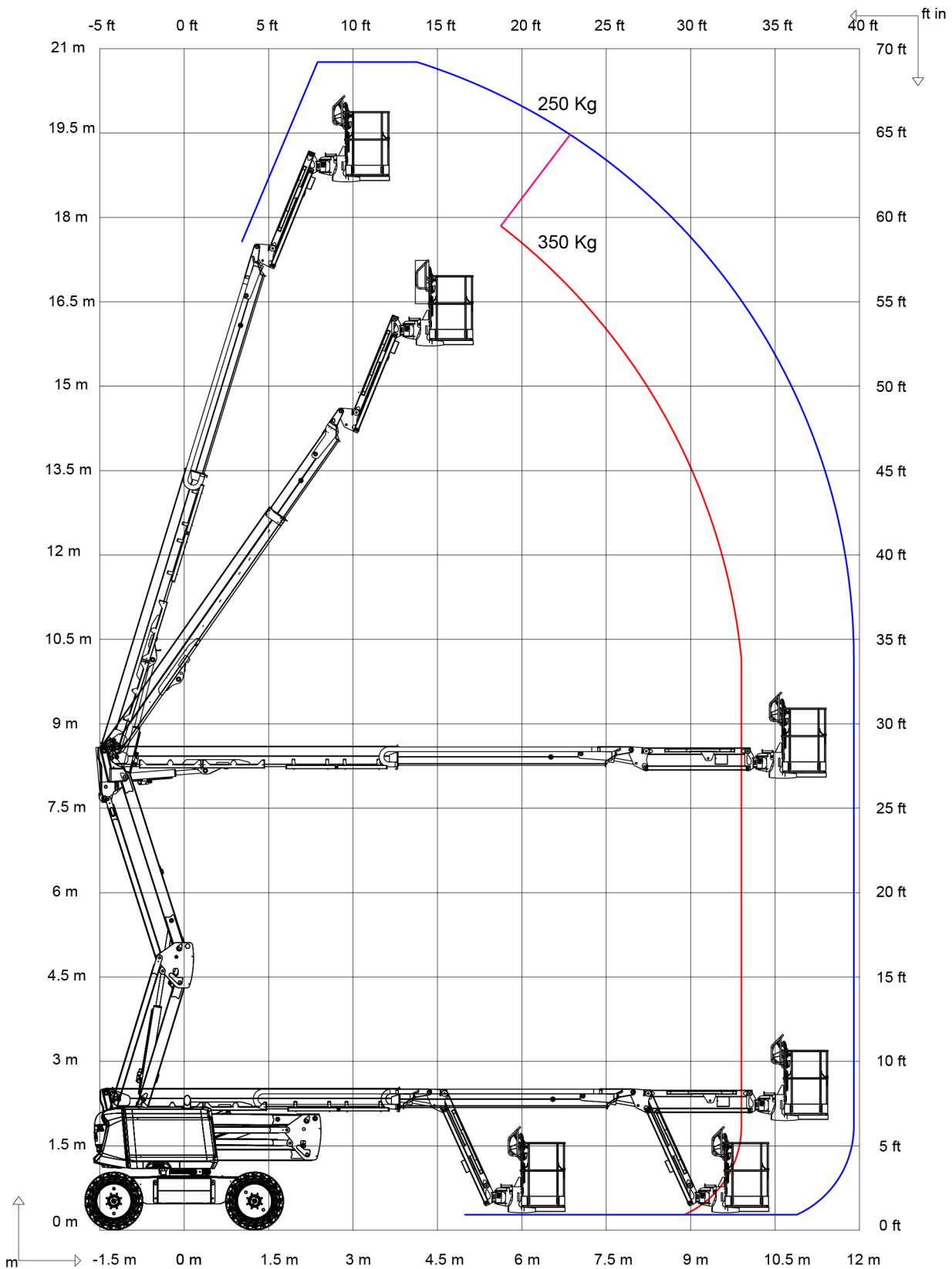

B - Familiarization

5 - Decals and markings locations

CE, UKCA and AS standards - 4000594350 H - HA20 LE - HA20 LE PRO

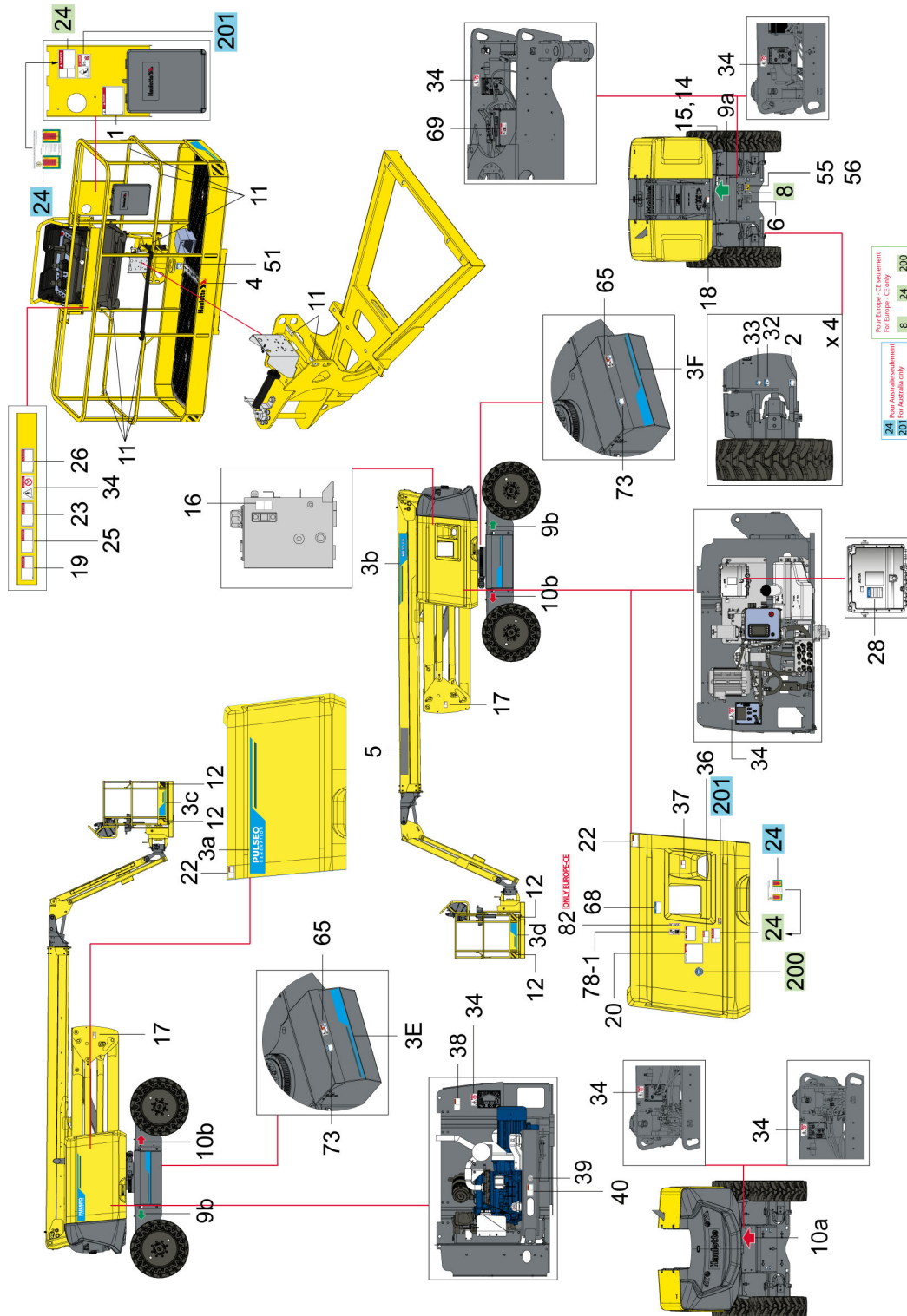

B - Familiarization

CE, UKCA and AS standards

Marking	Color	Description	Quantity	HA20 LE	HA20 LE PRO
1	Red	Height of the floor and load	2	4001074510	
2	Blue	Maximum Pressure per Tire - Floor Loading	4	4000359590	
3a	Other	Commercial name - PULSEO GENERATION	1		4000677540
3b	Other	Commercial name-Bright machine	1	4000677530	4000677550
3c	Other	Commercial name-Left basket	1		4000677570
3d	Other	Commercial name-Right basket	1		4000677580
3e	Other	Commercial name-Left battery	1		4000677600
3f	Other	Commercial name-Right battery	1		4000677590
4	Other	500 x 100 Decal HAULOTTE@Bright machine	1		307P217080
4	Other	500 x 100 Decal HAULOTTE@Dark machine	1		307P224740
4	Other	500 x 100 Decal HAULOTTE@Red machine	1		307P220360
5	Other	820 x 130 Decal HAULOTTE@Bright machine	1		307P217230
5	Other	820 x 130 Decal HAULOTTE@Dark machine	1		307P224930
5	Other	820 x 130 Decal HAULOTTE@Red machine	1		307P224920
6	Other	Identification plates	1	For CE and AS standards only : 4000700160 UKCA standard only : 4001188820	
8	Other	Noise emission level - 101 dB	1	For CE and UKCA standards only : 4000012860	
9a	Other	Control of movements - GREEN directional arrow	1		3078143930
9b	Other	Control of movements - GREEN directional arrow	2		4000699980
10a	Other	Control of movements - RED directional arrow	1		3078143940
10b	Other	Control of movements - RED directional arrow	2		4000699990
11	Other	Lanyard attachment points - Harness attachment compulsory	9		307P216290
12	Other	Material risk - Yellow and black adhesive tape	4		4000421700
14	Red	Risk of crushing - Spindle	1		4000027080
15	Other	Crown greasing	1		4000025160
16	Other	Max and min oil level	1		307P221060
17	Red	Risk of crushing - Do not park	2		4000024800
18	Orange	Hand crushing hazard - Risk of crushed hands	1		4000024890
19	Other	Read the operation manual	1		4000025140

B - Familiarization

Marking	Color	Description	Quantity	HA20 LE	HA20 LE PRO
20	Red	Operation instructions	1	In german : 307P222730 In english : 307P222740 In chinese : 4000698920 In korean : 4000618590 In croatian : 4000360810 In danish : 307P222760 In spanish : 307P222770 In estonian : 4000360870 In finnish : 307P222780 In french : 3078149030 In greek : 4000561810 In Hebrew : 4001208450 In hungarian : 4000360890 In italian : 307P222800 In japanese : 4000359830 In latvian : 4000359840 In lithuanian : 4000359850 In dutch : 307P222790 In norwegian : 4000359900 In polish : 4000359860 In portuguese : 307P222810 In romanian : 4000359870 In Russian : 4000359920 In slovakian : 4000359880 In slovenian : 4000359890 In swedish : 307P222820 In ukrainian : 4000359910	
22	Orange	Risk of crushing - Do not place foot	2	4000027090	
23	Red	Risk of crushing - Driving direction	1	4000024690	
24	Red	Danger of electrocution	2	For CA and UKCA standards only : 4000025070 AS standard only : 4000227500	
25	Red	Risk of crushing - Closing drop rail	1	4000025080	
26	Red	Danger of electrocution - Platform - Ground for welding	1	4000027100	
28	Other	Do not interchange	1	4000504670	
32	Blue	Towing anchorage point	4	4000027310	
33	Blue	Lifting anchorage point	4	4000027330	
34	Red	Electric Shock Hazards - Water projection	7	4000025130	
36	Red	Risk of crushing - Platform	1	4000027460	
37	Red	Risks of explosion	1	4000027370	
38	Orange	Hand crushing hazard - Heat burns	1	4000027450	
39	Other	Oil CJ 4 (if fitted)	1	4000019700	
40	Orange	Hand crushing hazard - Snapping up	1	4000027430	
49	Blue	Battery- +	1	4000071960	
50	Blue	Battery- -	1	4000071970	
51	Yellow	Socket - 240 V	1	4000027120	
55	Yellow	240V charger socket	1	4001110960	
56	Yellow	127V charger socket	1	4001110970	
65	Orange	Wear protective equipment	2	4000027440	
68	Other	Transport height	1	4000417480	
69	Other	Information-Battery isolation switch	1	4000711260	
73	Other	Information-Battery mass	2	4000700320	
78	Other	QR Code ( https://www.e-technical-information.com)	1	4001089310	

B - Familiarization

Marking	Color	Description	Quantity	HA20 LE	HA20 LE PRO
82	Other	Regeneration of diesel particles filter (STAGE V engine only)	1	For CE and UKCA standards only : 4001075370	
200	Other	Made in Europe	1	For CE and UKCA standards only : 4000137690	
201	Red	Wearing of a safety harness is essential	2	AS standard only : 3078144520	

A

B

C

D

E

F

G

H

I

B - Familiarization

EAC standard - 4000594360 G - HA20 LE - HA20 LE PRO

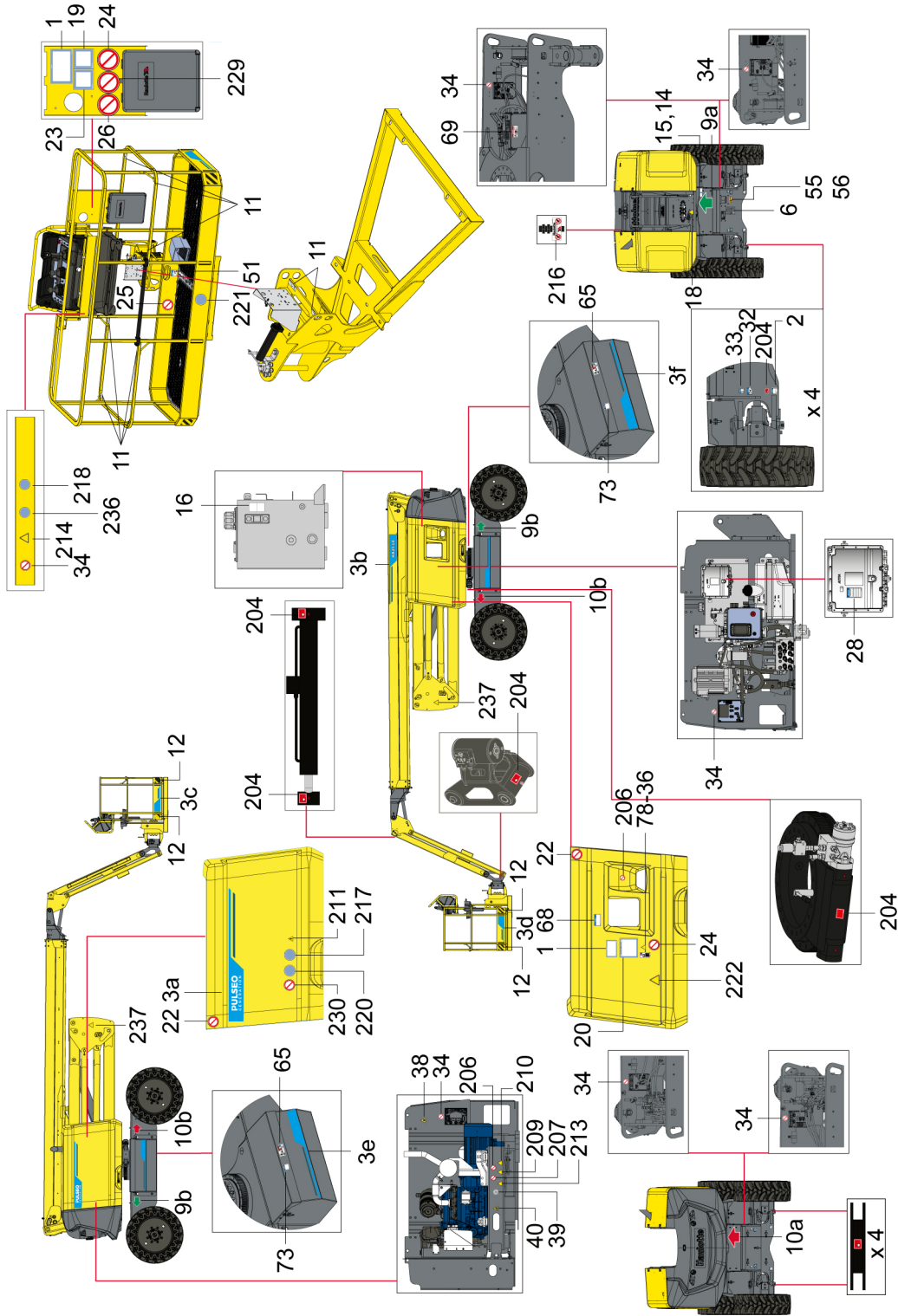

B - Familiarization

EAC standard

Marking	Color	Description	Quantity	HA20 LE	HA20 LE PRO
1	Red	Height of the floor and load	2	4000701540	
2	Blue	Maximum Pressure per Tire - Floor Loading	4	4000359590	
3a	Other	Commercial name - PULSEO GENERATION	1		4000677540
3b	Other	Commercial name-Bright machine	1	4000677530	4000677550
3c	Other	Commercial name-Left basket	1		4000677570
3d	Other	Commercial name-Right basket	1		4000677580
3e	Other	Commercial name-Left battery	1		4000677600
3f	Other	Commercial name-Right battery	1		4000677590
6	Other	Identification plates	1	For Russia : 4000278870 For Ukraine : 307P227830	
8	Other	Noise emission level - 101 Db	1	4000012860	
9a	Other	Control of movements - GREEN directional arrow	1	3078143930	
9b	Other	Control of movements - GREEN directional arrow	2	4000699980	
10a	Other	Control of movements - RED directional arrow	1	3078143940	
10b	Other	Control of movements - RED directional arrow	2	4000699990	
11	Other	Lanyard attachment points - Harness attachment compulsory	9	307P216290	
12	Other	Material risk - Yellow and black adhesive tape	4	4000421700	
14	Red	Risk of crushing - Spindle	1	307P227810	
15	Other	Crown greasing	1	307P227020	
16	Other	Max and min oil level	1	307P221060	
18	Orange	Hand crushing hazard - Risk of crushed hands	1	307P227660	
19	Other	Read the operation manual	1	For Russia : 307P227190 For Ukraine : 307P227840	
20	Red	Operation instructions	1	For Russia : 4000359920 For Ukraine : 4000359910	
22	Orange	Risk of crushing - Do not place foot	2	307P227010	
23	Red	Risk of crushing - Driving direction	1	307P227040	
24	Red	Danger of electrocution	2	307P226960	
25	Red	Risk of crushing - Closing drop rail	1	307P226950	
26	Red	Danger of electrocution - Platform - Ground for welding	1	307P226970	
28	Other	Do not interchange	1	4000504670	
32	Blue	Towing anchorage point	4	4000135970	
33	Blue	Lifting anchorage point	4	4000135960	
34	Red	Electric Shock Hazards - Water projection	7	307P226780	
36	Red	Risk of crushing - Emergency lowering	1	4000014290	
38	Orange	Hand crushing hazard - Heat burns	1	4000200810	
39	Other	Oil CJ 4 (if fitted)	1	4000318680	
40	Orange	Hand crushing hazard - Snapping up	1	307P226940	
49	Blue	Battery- +	1	4000071960	
50	Blue	Battery- -	1	4000071970	
51	Yellow	Socket - 240 V	1	4000027120	
65	Orange	Wear protective equipment	2	4000027440	
55	Yellow	240V charger socket	1	4001110960	
56	Yellow	127V charger socket	1	4001110970	

B - Familiarization

Marking	Color	Description	Quantity	HA20 LE	HA20 LE PRO
68	Other	Transport height	1	4000417480	
69	Other	Information-Battery isolation switch	1	4000711260	
73	Other	Information-Battery mass	2	4000700320	
78	Other	QR Code ( https://www.e-technical-information.com)	1	4001089310	
204	Other	Lubrication point	12	307P219370	
206	Other	Flames prohibited	2	307P226750	
207	Other	Smoking forbidden	1	307P226760	
209	Other	Battery danger	1	307P226790	
210	Other	Fire Hazard	1	307P226800	
211	Other	Electrical danger	1	307P226810	
213	Other	Corrosion hazard	1	307P226830	
214	Other	Danger unstable side	1	307P226930	
216	Other	Tamper-proof	2	307P227450	
217	Other	Caution glasses	1	307P227460	
218	Blue	Caution helmet compulsory	1	307P226680	
220	Other	Hand protection compulsory	1	307P227490	
221	Other	Obligatory routing	1	307P227510	
222	Other	Danger unstable side	1	307P227680	
229	Other	Do not travel down slopes in high speed	1	307P226990	
230	Other	No admittance	1	307P227560	
236	Blue	Caution glasses	1	307P226670	
237	Yellow	Risk of crushing	2	307P227670	

B - Familiarization

ANSI and CSA standards - 4000594370 H - HA61 LE - HA61 LE PRO

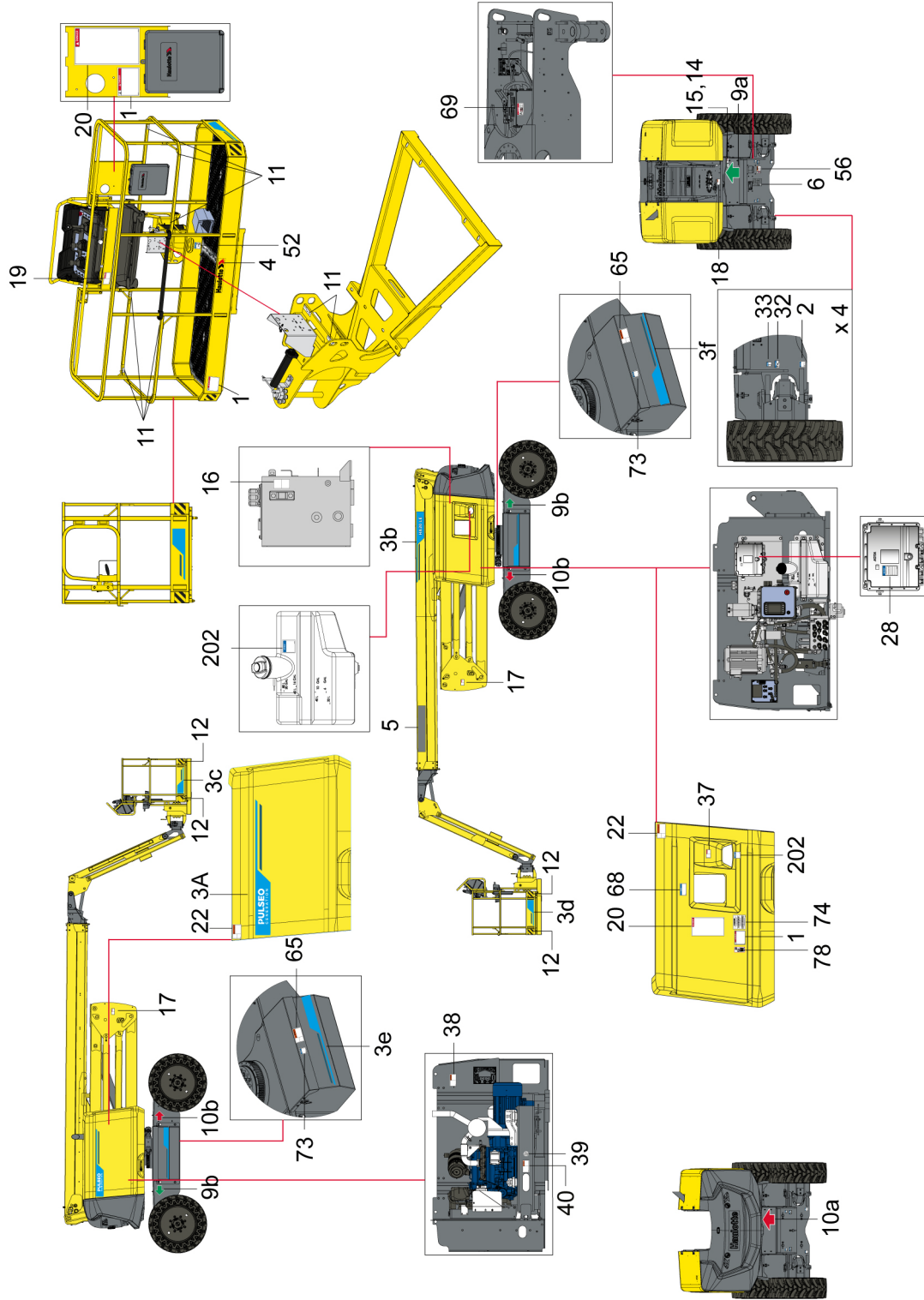

B - Familiarization

ANSI and CSA standards

Marking	Color	Description	Quantity	HA61 LE	HA61 LE PRO
1	Red	Height of the floor and load	3	4001074510	
1	Red	Height of the floor and load-Dual load	3	4001074520	
2	Blue	Maximum Pressure per Tire - Floor Loading	4	4000359590	
3a	Other	Commercial name - PULSEO GENERATION	1	4000677540	
3b	Other	Commercial name-Bright machine	1	4000700780	4000700800
3c	Other	Commercial name-Left basket	1	4000677570	
3d	Other	Commercial name-Right basket	1	4000677580	
3e	Other	Commercial name-Left battery	1	4000677600	
3f	Other	Commercial name-Right battery	1	4000677590	
4	Other	500 x 100 Decal HAULOTTE®Bright machine	1	307P217080	
4	Other	500 x 100 Decal HAULOTTE®Dark machine	1	307P224740	
4	Other	500 x 100 Decal HAULOTTE®Red machine	1	307P220360	
5	Other	820 x 130 Decal HAULOTTE®Bright machine	1	307P217230	
5	Other	820 x 130 Decal HAULOTTE®Dark machine	1	307P224930	
5	Other	820 x 130 Decal HAULOTTE®Red machine	1	307P224920	
6	Other	Identification plates	1	4000700170	
9a	Other	Control of movements - GREEN directional arrow	1	3078143930	
9b	Other	Control of movements - GREEN directional arrow	2	4000699980	
10a	Other	Control of movements - RED directional arrow	1	3078143940	
10b	Other	Control of movements - RED directional arrow	2	4000699990	
11	Other	Lanyard attachment points - Harness attachment compulsory	9	307P216290	
12	Other	Material risk - Yellow and black adhesive tape	4	4000421700	
14	Red	Risk of crushing - Spindle	1	In english : 4000024830 In french : 4000068080 In spanish : 4000086510	
15	Other	Crown greasing	1	4000025160	
16	Other	Max and min oil level	1	307P221060	
17	Red	Risk of crushing - Do not park	2	In english : 4000024640 In french : 4000067680 In spanish : 4000086460	
18	Orange	Hand crushing hazard - Risk of crushed hands	1	In english : 4000024770 In french : 4000067110 In spanish : 4000086490	
19	Other	Read the operation manual	1	4000025140	
20	Red	Operation instructions	2	In english : 4000027570 In french : 4000068880 In spanish : 4000086640	
22	Orange	Risk of crushing - Do not place foot	2	In english : 4000024840 In french : 4000068180 In spanish : 4000086610	
28	Other	Do not interchange	1	4000504670	
32	Blue	Towing anchorage point	4	4000027310	
33	Blue	Lifting anchorage point	4	4000027330	

B - Familiarization

Marking	Color	Description	Quantity	HA61 LE	HA61 LE PRO
37	Red	Explosion hazard	1	In english : 4000025010 In french : 4000068130 In spanish : 4000086560	
38	Orange	Hand crushing hazard - Heat burns	1	In english : 4000025040 In french : 4000068110 In spanish : 4000086540	
39	Blue	Engine oil - CJ-4	1	4000019700	
40	Orange	Hand crushing hazard - Snapping up	1	In english : 4000025020 In french : 4000068100 In spanish : 4000086530	
49	Blue	Battery- +	1	4000071960	
50	Blue	Battery- -	1	4000071970	
52	Blue	Socket - 110 V	1	4000027590	
56	Yellow	127V charger socket	1	4001134690	
65	Orange	Wear protective equipment	2	In english : 4000025030 In french : 4000068120 In spanish : 4000086550	
68	Other	Transport height	1	4000417480	
69	Other	Information-Battery isolation switch	1	4000711260	
73	Other	Information-Battery mass	2	4000700320	
74	Other	California warning - P65	1	4001026850	
78	Other	QR Code ( https://www.e-technical-information.com)	1	4001089310	
202	Other	Diesel Fuel Only	2	4000201430	

C - Pre-operation inspection

1 - Recommendations

The owner, the site manager, the supervisor and the operator are all responsible to ensure the machine is fit for the work it is to perform; i.e. that the machine is suitable to carry out the work in complete safety and in compliance with this Operator's Manual. All managers who are responsible for persons operating the machine must be familiar with the local regulations currently applicable in the country of use and ensure that they are adhered to.

Before using the machine, read the previous chapters in this manual. Ensure that you have understood the following points :

- Safety precautions.
- Operator's responsibilities.
- Conditions and the operating principles of the machine.

2 - Working area assessment

Before any operation :

- Carry out a thorough inspection of the site to identify any potential risks within the work zone.
- Take the necessary precautions to avoid collisions with other machinery within the work zone.

Ensure that :

- The weather conditions (wind, rain, etc.) allowing the machine to be used.
- The ground withstands the weight of the machine and has not been affected by the poor weather conditions.
- Check that the authorisations to work with the machine on the site in question have been obtained (.g. chemical product factories).
- Define a rescue plan for all the risks, including the risk of falls and crushing.

Extra care must be taken if aerial work platforms are used to manoeuvre up through several levels of steelwork. There is a risk of the operator being trapped should the basket strike the steelwork.

This risk increases with the number of steelwork levels and if material is piled up on lower level reducing the spacing between levels.

C - Pre-operation inspection

3 - Inspection and Functional test

3.1 - DAILY INSPECTION

Each day before the beginning of a new work session and with each change of operator, the machine must be subjected to a visual inspection and a complete functional test.



- Never use a defective or a malfunctioning aerial work platform.
- If any item on the check list is marked "No" during the inspection; machine must be tagged and placed out of service.
- Do not operate the machine until all identified items are corrected and it has been declared safe for operation.

In case of loose fasteners, refer to torque table value in maintenance book.

In case of leaks, replace the damaged part before use.

In case of structural part deformation (cracks, broken weld, paint chips) replace the part before use.



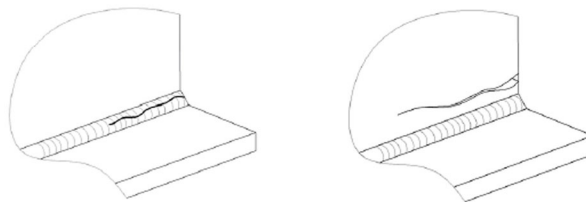





Sample of broken welds



We recommend these forms to be completed daily and stored to assist with your maintenance schedule.

Each action is depicted in the daily inspection sheet using the following symbols.

Use the detailed program below.

	Oil change		Lubrication-Lubrication		Tightening
	Levelling		Systematic replacement		Functional adjustments / Checks / Cleaning
	Visual inspection		To check by test		

Serial number : Hours of operation : HAULOTTE Services® contract reference : Intervention record number : Date : Name :	Model : Signature :
--	----------------------------

C - Pre-operation inspection



















HA20LE / HA20LE PRO

	Page or associated procedure	Daily	K O	N O K	Corrected	Comments
Chassis assembly : Wheel, reducer, steering, wheel pivot						
Check state of tires/tyres and inflations						
Thermal engines						
Check engine fuel level (Top up the oil if necessary)						
Check engine oil level (Top up the oil if necessary)						
No leaks from engine components (engine, hoses, radiator)						
Check the condition of the battery						
Check the cooling circuit level (Top up the oil if necessary)						
Check the operation of the lock on the engine casing						
Batteries						
Check the condition of the battery						
Turntable						
Test the operation of the turntable locking system						
Hydraulic : oils, filters and hoses						
Check the hydraulic oil level (Top up the oil if necessary ; Machine stowed)						
Check the clogging indicator on the hydraulic pressure filter (change if clogged)						
Check the hoses, blocks and pumps, fittings, cylinders and the tank for the absence of leaks, deformations and damage						
Platform						
Ensure that the gate or sliding bar shall be designed to either return automatically to the closed and latched position						
Check that the harness anchor points are not cracked or damaged						



C - Pre-operation inspection

HA20LE / HA20LE PRO

	Page or associated procedure	Daily	O K	N O K	Corrected	Comments
General						
Check for the presence, cleanliness and readability of the manufacturer's plates, security labels, user manual and maintenance manual						
Check the cleanliness and readability of the control box						
Test the opening and closure of covers (chassis, turntable, upper control box)						
Check the condition of electrical harnesses, cables and connectors						
Check for the absence of abnormal noise and jerky movements						
Check for the absence of visible deterioration and damage						
Check for the absence of cracks, broken welds and chipped paintwork on the structure						
Check for the absence of missing or loose screws and bolts						
Check for the absence of deformation, cracking and breakage of axis stops, bushing and axes						
Check for the absence of foreign bodies in joints and sliding parts						
Safety devices						
Test the operation of the upper and lower control boxes: manipulators, switches, buttons, horn, emergency stops, screens and lights						
Test the operation of visual and audible alarms						
Test the operation of the tilt system						
Test the operation of the emergency lowering system						
Test the operation of the axle locking system						
Test the operation of the loading control system (visual alarm on the control box)						
Test the operation of the Activ Shield Bar (If equipped)						

C - Pre-operation inspection

4 - Safety functional checks

To protect the user and the machine, safety systems prevent the movement of the machine beyond its operating limits. These safety systems when activated immobilize the machine and prevent further movement.

The operator must be familiar with this technology and understand that is not a malfunction but an indication that the machine has reached an operation limit.

Aerial Work platforms are equipped with two control boxes which allow operators to safely use the machine. An auxiliary system (Overriding system) is available on the ground control box in order to rescue anyone trapped on the platform.

The following checks describe the operation of the machine and the specific controls required.

For the location and description of these controls :  refer to section B 3.2 and D 2 - Ground control box and B 3.3 and D 3 - Platform control box.

4.1 - E-STOP BUTTON CHECK

Ground control box E-stop button

Step	Action
1	Pull the E-Stop button (9) at the ground control box.
2	Set the key switch (21) at ground box to the  position.
3	The indicator (10) lights up on ground control box.
5	Push the E-stop button (9).
6	Check that the screen turns off.
7	Check no movements are functional.

Platform control box E-stop button

Step	Action
1	Pull both E-Stop buttons (9) at ground box and (46) at platform box.
2	Set the key switch (21) at ground box to the  position.
3	The indicator (13) lights up on ground control box.
4	Push in E-Stop button (46) at platform.
5	Check no movements are functional. The indicators go out.

4.2 - ACTIVATION OF CONTROLS

The enable foot pedal (enable switch) (C42) must be activated to allow any movement.

The "Enable Switch" system depends on the machine configuration and will consist of one of the following :

- Joystick trigger at platform box (if fitted).
- Foot pedal (enable switch) in the platform.
- Enable switch at ground box.

C

- Pre-operation inspection

4.3 - FAULT DETECTOR

The machine is equipped with an on-board fault detection system, which indicates the type of fault to the operator.

The fault is identified by a default code.

The default code is displayed at the ground control box.

According to the type of fault, the machine MAY switch into DOWNGRADEMODE mode and certain movements are prevented to maintain Operator's safety.

Do not use the machine until the fault has been corrected.

4.3.1 - Indicators/LED's test

From the ground control box

Step	Action
1	Pull the E-Stop button (9) at the ground control box.
2	Set the key switch (21) at ground box to the  position
3	Check that the LEDs (10, 15, 16) light up on ignition and that the touch screen display is also lit up
4	Check that the LED's on the display are all turned off after 1 sec.

From the platform control box

Step	Action
1	Pull the E-Stop button (9) at the ground control box.
2	Set the key switch (21) at ground box to the  position
3	Check that the LEDs (13, 15, 16) light up on ignition and that the display is also lit up
4	First push in the E-Stop button (46) at platform box, then pull out.
5	Check that the LED's (101 - 117) light up on the platform display panel.
6	Check that the LED's (101 - 117) on the display are all turned off after 1 sec.

4.3.2 - Buzzers test

From the ground control box

Step	Action
1	Pull the E-Stop button (9) at the ground control box.
2	Set the key switch (21) at ground box to the  position.
3	Verify that the buzzers at the ground and platform beep.

C - Pre-operation inspection

4.4 - AUTOMATIC ENGINE CUT-OUT

If the machine is in Forced Mode, the engine automatically cuts out in the following conditions :

- The alternator is not functioning.
- Engine temperature is too high.
- Oil pressure is too low.
- The E-stop(s) is (are) pushed in.
- The machine is switched off.

If the machine is in Auto Mode, refer to the section on operating modes :  Section D 1.5 - Mode operation.

4.5 - OVERLOAD SENSING SYSTEM

If the platform load exceeds the maximum allowed load, no movement is possible from the 2 control boxes.

At ground and platform control boxes a buzzer sounds and an indicator light warns the operator.

To return the machine to normal operation remove weight from the platform until the load is below the maximum allowed load.

Daily check that the LED's illuminate when the machine is switched on :

- Verify that the Overload system is active : Refer to Indicator (15) at ground control box and LED (114) at platform control box display.
- Verify that the buzzers are functioning : Refer to Buzzers test.

A periodic inspection of this device must be performed according to the recommendation in Maintenance Schedule.

4.6 - OSCILLATING AXLES (IF EQUIPPED)

To improve the driving capability on rough terrain, the front axle is equipped with an oscillating mechanism. When the scissor arms are folded, the oscillating axle is unlocked to adapt to uneven ground and help machine stability. When the scissor arms are extended, a safety device locks the oscillating axle to reduce overturning hazard.

A visual inspection must be performed to ensure the absence of leaks from the oscillating cylinder and associated plumbing connections including the hydraulic hoses.

A periodic inspection of this device must be conducted according to the recommendation in the maintenance schedule.

C

- Pre-operation inspection

4.7 - SLOPE WARNING DEVICE

From each control box, a buzzer alerts the operator that the machine is not folded/stowed and is positioned on a slope exceeding the slope allowed.

N.B.-: *The slope sensor is only active when the platform is not in the stowed position.*

When machine is on a slope greater than the rated slope, with extending structure out of the stowed position :

- The DRIVE and LIFTING (RAISING) commands are deactivated.

The lowering speeds are reduced.

In this case, fully lower the platform and reposition the machine on level ground before raising the platform again.

To check the tilt sensor at ground level, perform the following steps :

To check the tilt sensor at ground level

Step	Action
1	Put the machine in stowed position.
2	Position the machine on an incline that is greater than the maximum permitted incline ( Section B 4.1 - Technical specifications).
3	Check that the "tilt" LED 112 indicator is lit up.
4	Lift the platform. Ensure the movement is stopped.
5	Buzzers at ground and platform will beep.

4.8 - TRAVEL SPEED LIMITATION

The drive speed selector switch (45) on the platform control box controls the 3 speed selection (fast, medium, slow/up and down a ramp).

All driving speeds are authorised when extending structure of the machine is in stowed position (transport configuration). Drive speed is proportional to the movement of the drive joystick (33). Adjust position of Jib to enhance field of vision during driving.

Whatever the position of the drive speed selector switch (45) on the platform control box, the drive speed is limited when the machine is unfolded.

Daily check that the speed is limited to less than 1 km/h (0.6 mph) when :

- The boom is raised by more than 10° above horizontal.
- The boom is telescoped/extended more than 400 mm (16 in).
- The arm is raised by more than 2 m (6 ft 7 in) above horizontal.

When the machine is on a slope in a stowed position, drive speed may be reduced depending on the incline.

The only speed allowed when not in stowed position is microspeed (This speed is a default speed programed into the machine). Refer to  Section B 4.1 - Machine specifications.

C - Pre-operation inspection

4.9 - ON-BOARD ELECTRONICS

The machine is equipped with a specific calculator configured for this machine's functionalities. Do not interchange the Calculator (calibration restoration) between machines..

4.10 - LOAD SELECTION SYSTEM (IF FITTED)

The machine is equipped with a selector load capacity (250 kg (550 lbs) or 350 kg (770 lbs)). In case that the capacity 350 kg (770 lbs) is selected, the work area is automatically limited.

Refer to  Section B 4.2 - Working area / Range of motion.

Daily check :

- From the ground control box :
 - Switch on the machine.
 - Pull out the E-Stop buttons at the ground and platform boxes.
 - Start the engine.
 - Fully stow the machine on flat ground with the boom fully retracted.
 - Check that the load selector (82) on the platform control box is on 350 kg (770 lbs).
 - The LED (117) at platform display panel lights up.
- From the platform control box :
 - Turn the load selector (82) on 350 kg (770 lbs).
 - Extend the telescoping boom.
 - Boom extension stops automatically when the LED (113) lights up.
 - Raise the boom until the indicator/LED (113) light turns off.
 - Fully extend the telescoping boom.
 - Lower the boom. Lowering stops automatically, indicator/LED (113) lights.
 - Retract the telescoping boom.
 - Lower the boom.
 - The indicator/LED (113) goes out.

D - Operation instructions

1 - Operation

1.1 - INTRODUCTION

Only trained and authorized personnel shall be permitted to operate this aerial work platform.
Prior to operation :

- Read, understand and obey all instructions and safety precautions in this manual and attached to the aerial work platform.
- Read, understand and obey all local regulations.
- Become familiar with the proper use of all controls and emergency systems.



1.2 - MAJOR DESCRIPTION

All the machines are equipped with :

- Platform control box.
- Ground control box (Overriding system).

1.3 - OPERATION FROM THE GROUND CONTROL BOX

The ground control box is designed for maintenance and emergency rescue operations only.

- The ground control box is energized and is active ONLY when :
 - The emergency stop on the ground control box is not pushed in.
 - Activation of ground control box is achieved by turning the control box activation key selector (21) to  the  position.
- An E-Stop button at each control box stops all movements when pressed in; including shutting off an engine (if equipped).

N.B.:-DO NOT turn off the power supply of the machine using the E-stop button(Use ONLY in case of emergency). Turn off the power supply of the machine using the Control box activation key switch (21)

to  position.

- An Enable /Foot Switch (6) is present that should be activated and maintained to authorize one or more movements. If Enable Switch (6) is kept engaged without selecting a function movement for more than 8 seconds ; Enable Switch is automatically de-activated.
- Only movements to lift, lower and rotate the platform are possible from the ground control box.
- All controls operating a movement, return automatically to neutral when released.
- At power up, all controls must be in their neutral position (not activated).
- Enable Switch (6) and Back-up unit selector (17) :
 - When the engine is running, the switch (6) operates as an activation control only.
 - If the engine is stopped, the switch (17) operates as an activation control and activates the back-up unit (emergency pump).
- Overriding system : Refer to  Section D 4.2 - To rescue operator in platform.

D

- Operation instructions

- The status of the controls is tested automatically when the machine is switched on.
- Indicators (10), (15), and (16) are checked when the machine is powered on.
- If the control box activation selector key for the console (21) is positioned either on the ground control box or the platform control box, the machine is automatically switched on in Full Electric mode. However, there are 2 other modes that can be selected as necessary :
 - If Forced Engine Mode button (20) is activated, the engine will turn ON, regardless of the battery level.
 - If the Auto Mode button (19) is activated, the engine will automatically start or stop, depending on the battery charge level (Refer to :  Section D 1.5 - Mode operation.).
- A buzzer beeps in the following conditions :
 - When power is switched on.
 - Overload.
 - Slope if machine is out of stowed position.
 - Hydraulic oil overheating.
 - Movement buzzer option.
 - Drive buzzer option.

D - Operation instructions

1.4 - OPERATION FROM THE PLATFORM CONTROL BOX

- The platform control box is energized only when :
 - The E-stop buttons on both ground and platform control boxes are not pressed in.
 - The machine is switched ON by turning the activation key selector from the ground control box (21) to the platform control box .
 - Overriding system not activated.
- A faulty joystick is not taken into account to control a movement. If this fault disappears, the movement is authorised again.
- An E-Stop button at each control box stops all movements when pressed in; including shutting off an engine (if equipped).

N.B.:-DO NOT turn off the power supply of the machine using the E-stop button (Use ONLY in case of emergency). Turn off the power supply of the machine using the Control box activation key switch (21)

to  position.

- A Foot Switch (C42) is present and should be activated and maintained to authorize one or more movements. If Foot Switch is kept engaged without selecting a function movement for more than 8 seconds ; Enable switch is automatically de-activated.

N.B.:-It is recommended that operator removes the foot from the Foot Switch whenever a movement has ceased.

- The release of 'Enable switch' foot pedal while performing a movement stops that function movement and all other movements are inactive. The stop of movements is progressive.
 - If the Foot Switch is pressed again quickly within 0,5 s the movement restarts.
 - If the Foot Switch and / or Enable Switch is not pressed again quickly enough within + 0,5 s the movement will not restart. It could restart only when the selected function switch/joystick is released to neutral position.
- All switches and joystick operating a movement, return automatically to neutral when released.
- At power up, all switches and joysticks must be in their neutral position.
- The status of the switches is tested automatically when the machine is switched on and checked at every starting. A switch will be activated only after it has been detected in neutral position.
- A buzzer beeps in the following conditions :
 - When power is switched on.
 - Overload.
 - Machine elevated on a slope greater than the rated slope.
- Emergency pump (if the motor pump unit or traction batteries fail) ( Section D 4.1 - In case of power loss).
- Indicators - All indicators (LEDs 101 - 117) are checked when the machine is powered on.

D

 - Operation instructions**While driving on a slope :**

- While driving, always place the boom above the rear axle, in the direction of movement.
- Always orientate the machine in the direction of the slope.
- Always place the boom in fully retracted and in stowed position.
- Do not travel down slopes in high speed.
- Do not drive fast in narrow or cluttered areas. Keep speed under control while making turns or sharp bends.

D - Operation instructions

1.5 - MODE OPERATION

1.5.1 - Full Electric mode

When the machine is switched on, it will be in Full Electric mode  by default (battery power supply, engine off).

- If the battery charge status is less than 30 %, it is not possible to control several movements simultaneously.

N.B.:-Driving and / or steering is considered a movement.

- When the battery has less than 20 % charge, the following movements are disabled :
 - Boom raising
 - Arm raising
 - Telescope extended
 - Drive if the machine is stowed.
- If the batteries are discharged below 5 %, no movement is available. Recharging the batteries, either connected to the mains or when starting the engine, is mandatory (Refer to  Section D 7 - Battery care and maintenance).

The machine's main power supply can only be switched off from the ground control box by turning the control box activation key selector (21) to OFF .

1.5.2 - Auto mode

In this mode , the engine will automatically start or stop. The level of charge in the batteries is managed to optimize their life by minimizing energy consumption with the use of the thermal engine. Thereby, machine's performance level is maintained.

The thermal engine will start :

- If the battery has between 70 % and 90 % charge and depending on movements made.
- If the state of the battery charge is less than 70 % and the operator activates a movement (by pressing the control (6) or the activation pedal (C42) on the platform).

The thermal motor will stop :

- If the state of the charge is greater than 90 %.
- If the batteries charge charge is between 80 % and 90 % and if there is no movement.

D - Operation instructions

If the battery charge status is less than 30 %, it is not possible to control several movements simultaneously.

N.B.:-Driving and / or steering is considered a movement.

- When batteries are discharged below 5 %, no movement is allowed.

N.B.:-Recharging the batteries, either connected to the mains or when starting the engine, is mandatory (Refer to  Section D 7 - Battery care and maintenance).

The engine cannot start unless the enable switch (6) at ground control box or the enable switch "foot pedal" (C42) at platform is activated.

To stop the engine and return to Full Electric mode, press the Automatic Mode selector (19).

The machine's power supply can only be turned OFF from the ground control box by turning the control box activation key selector (21) to the OFF  position.

1.5.3 - Forced engine mode

This mode  can be selected any time.

The engine drives a generator and the current provided will recharge the batteries up to 95 %.

When the batteries reach 95 % charge, the engine will automatically stop and the machine will run in Start & Stop. The engine can be restarted by pressing the activation selector (6) or the dead man's pedal (C42) on the platform.

If the battery charge status is less than 30 %, it is not possible to control several movements simultaneously.

N.B.:-Driving and / or steering is considered a movement.

- When batteries are discharged below 5 %, no movement is allowed. Recharging the batteries, either connected to the mains or when starting the engine, is mandatory (Refer to  Section D 7 - Battery care and maintenance).

To stop the engine and return to Full Electric mode, press the Manual mode selector (20).

If there is a fault on the engine or the generator, the machine automatically switches to Full Electric mode.

The machine's power supply can only be turned OFF from the ground control box by turning the control box activation key selector (21) to the OFF  position.

D - Operation instructions

1.5.4 - Overview of mode operation

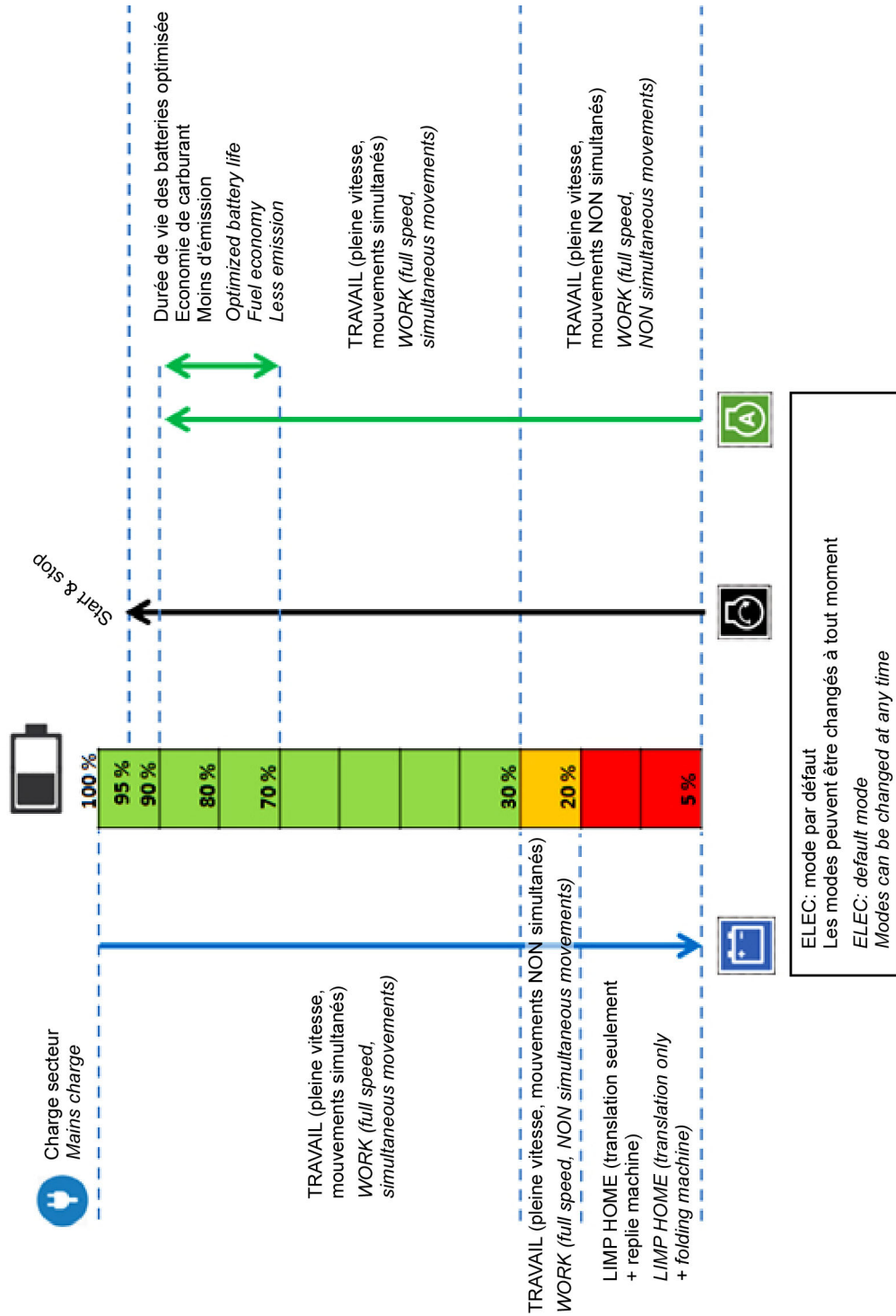

Energy management: use of batteries



D - Operation instructions

2 - Ground control box

2.1 - TO START AND STOP THE MACHINE

- Check that the E-stop buttons (9) at ground control box and (46) at platform control box are not pressed in.
- Turn the control box selector (21) to position  to energize the ground control box. Full Electric mode (18) is activated by default (the engine does not start). However, two other modes can be selected to power up :
 - If Forced mode (20) is selected, then the engine will start.
 - If Auto mode (19) is selected, the engine will only start depending on how much charge remains in the battery (Refer to :  Section D 1.5 - Mode operation.).

To shut-down the machine from the ground control box :

- Turn the activation selector key switch (21) to off position .
- Power supply is now switched off.

N.B.:- This operation turns off the power supply to machine and it is required to prevent battery discharge.

N.B.:- The Activ'Screen automatically goes into standby if it is not used for an extended period. To switch the Activ'Screen back on, turn the key selector to position OFF then follow the start-up procedure.

D - Operation instructions







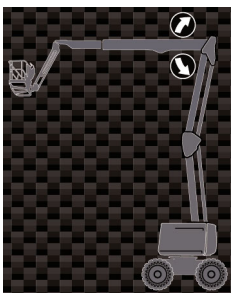

2.2 - MOVEMENT CONTROL

Platform leveling is available, regardless of the work height. Even at low movement speeds, use the controls with caution.

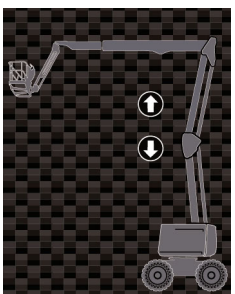

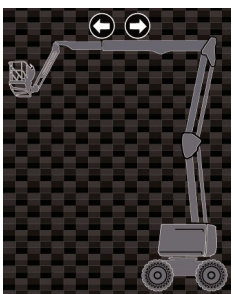

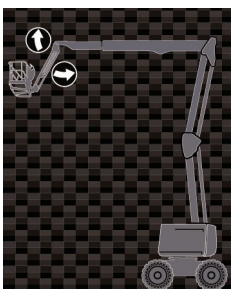
N.B.:-Releasing the Enable Switch (6) will stop all movements.

Activate the desired control and the 'Enable switch' (6) simultaneously to perform that selected function.

Ground box controls (emergency station)

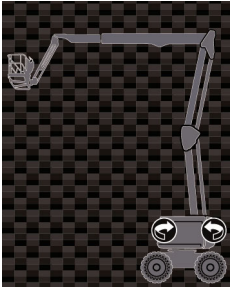
Command		Action
Raising / lowering of boom		Press the boom raising control (4)  to raise the boom.
		Press the boom lowering control (4)  to lower the boom.
Raising / lowering of arm		Press the arm raising control (5)  to raise the arm.
		Press the arm lowering control (5)  to lower the arm.
Boom telescoping extend / retract		Press the boom telescoping control (3)  to extend the boom.
		Press the boom retracting control (3)  to retract the boom.
Jib raising / lowering (If equipped)		Press the jib raising control (2)  to raise the jib.
		Press the jib lowering control (2)  to lower the jib.

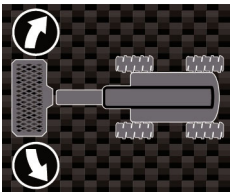
D - Operation instructions

Command	Action
Turntable rotation 	Press the turntable rotation control (7)  for a clockwise (CW) rotation. <hr/> Press the turntable rotation control (7)  for a counter-clockwise (CCW) rotation.
Platform rotation 	Press the platform rotation control (8)  for a clockwise (CW) rotation. <hr/> Press the platform rotation control (8)  for a counter-clockwise (CCW) rotation.

D - Operation instructions

3 - Platform control box

3.1 - TO START AND STOP THE MACHINE

3.1.1 - To start the machine

At the ground control box :

- Check that the E-stop button (9) is not pressed in.
- Turn the control box activation key selector (21) to platform control box position  to switch on the platform control box.

At the platform control box :



- Check that the E-stop button (46) is not pressed in.
- The power on LED (101) at the platform display lights up.

If the activation key selector for the control box (21) is activated, the machine is in Full Electric mode by default. Refer to the section on operating modes :  Section D 1.5 - Mode operation.

3.1.2 - To stop the engine

The engine stops and the machine returns to Full Electric mode if :

- In Manual mode, selector (20) on the ground control box is pressed or switch (20) on the platform control box is in the upwards position ;
- In Auto mode, selector (19) on the ground control box is pressed or switch (19) on the platform control box is in the upwards position.

The machine's power supply can only be turned OFF from the ground control box by turning the control box activation key selector (21) to the OFF  position ( Section D 1.5 - Mode operation).



The Activ'Screen automatically goes into standby if it is not used for an extended period. To switch the Activ'Screen back on, press the emergency stop button then follow the start-up procedure.

D - Operation instructions

3.2 - MOVEMENT CONTROL

Activate the desired control and the Foot Switch simultaneously to perform that selected function.

Foot Switch

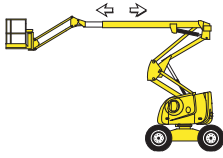
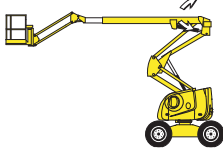
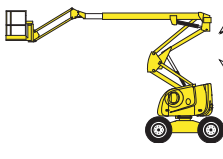
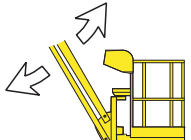

Command	Action
Boom telescoping extend / retract 	Push the boom telescoping switch (54) upwards to retract the boom. Push the boom telescoping switch (54) downwards to extend the boom.
Boom raising / lowering 	Move the boom/turntable joystick (49) forward to raise the boom. Move the boom/turntable joystick (49) backwards to lower the boom.
Arm raising / lowering 	Push the arm joystick (50) forwards to raise the arm. Push the arm joystick (50) backwards to lower the arm.
Jib raising / lowering 	Push the jib switch (129) upwards and hold to raise the jib. Push the jib switch (129) downwards and hold to lower the jib.

D - Operation instructions

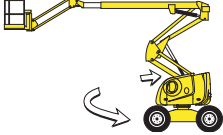
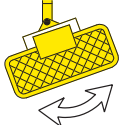
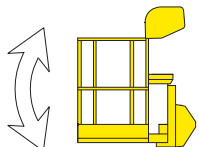
Command	Action
Turntable rotation 	Move the boom/turntable joystick (49) to the left for a clockwise (CW) rotation. Move the boom/turntable joystick (49) to the right for a counter clockwise (CCW) rotation.
Platform rotation 	Move the platform rotation switch (38) to the right for a counter clockwise (CCW) rotation. Move the platform rotation switch (38) to the left for a clockwise (CW) rotation.
Platform leveling 	Move the platform levelling switch (40) upwards to raise the platform to the front of the machine. Move the platform levelling switch (40) downwards to tilt the platform to the rear of the machine.

A

B

C

D

E

F

G

H

I

D - Operation instructions

3.3 - ADDITIONAL CONTROLS

- Horn : Push the horn selector (43) to the right to sound the horn. The horn stops when the switch is released.

3.3.1 - Activ' Lighting System

Refer to  Section B 3.3 - Platform control box.

This option means that the operator will be able to safely load (or unload) the machine onto the truck.

Located on the turntable, boom and platform, the Activ' Lighting System system lights up the controls and surrounding areas of the machine. Users can then safely move the machine.

3.3.2 - Dual load selector (if fitted)

N.B.:-The load selection (82) must be done only in static position. Load selection can be done only from the platform control box.

- When the machine is switched on (whatever control box is selected) the machine recognizes the load per the selector (82) position on the platform control box (350 kg (770 lbs) or 250 kg (550 lbs)).
- When 350 kg (770 lbs) is selected, movement is automatically cut off when the machine reaches the limit of the 350 kg (770 lbs) work zone. The load selection indicator (LED 109) is on.
- When 250 kg (550 lbs) is selected, there is no load chart limit. The load selection indicator (LED 109) is on.
- All movements are authorized.

To safely utilize the working area/range of motion, follow the below steps and as shown in the illustrations :

1. If boom lowering is cut-off, then retract the boom to recover the lowering movement.
2. If boom telescoping is cut off, lift the boom to recover the boom telescoping movement.

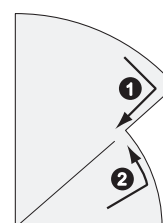

N.B.:-The work zone corresponds to the position of the 250 kg (550 lbs) / 350 kg (770 lbs) load selector. The work zone refers to the label located on the platform. If the platform load is between 250 kg (550 lbs) and 350 kg (770 lbs), then the platform cannot be positioned in the restricted area.

N.B.:-If the load selection indicator (LED 109) flashes, this means that the load selection has not been taken into account. Retract the telescope to the stop then select the load again using the load selector (82).

D - Operation instructions

4 - Rescue and emergency procedures

4.1 - IN CASE OF POWER LOSS

In case of loss of the main power source, the secondary (back-up) power unit, powered by the starting battery, allows movements to be controlled from both the ground and platform control boxes.

As the electric pump has limited power, it is advisable to reach the ground in the most direct manner possible.

The use of the electric pump is exclusively reserved for lowering the boom in emergency situations only. You are advised to retract the telescope before lowering the boom.

N.B.:- Test the operation of emergency system at least once a month. Refer to the Service Manual.

Depending on the control box in use, push and hold the back-up/auxiliary power switch (17) at ground box or switch (41) at platform box. Retract the boom and lower it by using switches (3) and (4) at ground box or switch (54) and joystick (49) at platform box.

In an emergency, if the operator has to exit the platform while it is elevated, the transfer of the operator must respect the following recommendations. :

- Exit onto a sturdy and safe structure.
- Allowance must be made for the possibility of boom deflection when egressing from the platform.
- The occupant(s) must ensure that 2 lanyards are used for security/safety. One must be attached to the designated anchorage point on platform the occupant(s) is in and the other attached to the structure intended to get on.
- Do not leave platform without taking into account the allowance for possibility of boom deflection when exiting platform.
- Occupant(s) must exit the current platform through the normal access.

N.B.:- Do not detach the lanyard from the current platform if the transfer to the new structure poses any danger or until the transfer is safely completed. Do Not attempt to climb down the boom. Instead wait for assistance for a safe exit.

D - Operation instructions

4.2 - TO RESCUE OPERATOR IN PLATFORM

In a situation where an operator located in the platform needs to be rescued (for example in case of illness, injury or trapped against a structure making the control box inaccessible), the rescue personnel at ground level needs to obtain rapid and direct access to operating functions.

HAULOTTE® has implemented a control system for safely lowering the operator to the ground in the event of an emergency to enable him to receive the necessary treatment.



The system allows occupant(s) to be lowered to the ground level, even if an E-Stop is engaged or if an overload is detected.

In this situation, supervisor(s) at ground level must turn the control box key selector (21) to the ground control box  position to take control.

To safely operate the machine from the ground control box, press and hold the emergency back-up unit selector (17) .

Procedure :

- Turn the ground control box key control (21) to the ground control box  position.
- The platform box controls are now de-energized.
- Check that the E-Stop button (9) at ground is not pressed in.
- To lower the platform, hold down the emergency back-up unit selector (17) and simultaneously activate the desired control function.







4.2.1 - Operation of overriding system from ground control box

N.B.-: If the safety systems do not allow normal movement from the ground control box, or in the event of overheating, use the overriding system described below.



Operation of the "overriding system" switch must be an exception and not a normal emergency operation.

Procedure :

- Press and hold the "overriding" system control (11) .
- Press simultaneously the telescoping boom control (3)  to retract the boom.
- Press the boom raising control (4)  to raise or  lower the boom.
- Press the arm raising control (5)  to raise or  lower the arm.

N.B.-: Once rescue operations are complete, write an incident report.

4.3 - NO POWER AVAILABLE

D - Operation instructions

In case of loss of the main power and the secondary power unit not functioning, do not attempt to activate any function movement using hydraulic manifold unless trained and authorized by HAULOTTE Services®. All safety functions are no longer active and several hazards may occur. Improper use of the equipment will result in death or serious injuries.



If the operator cannot be lowered by any of the above mentioned methods, contact HAULOTTE Services® immediately.

A

B

C

D

E

F

G

H

I

D - Operation instructions

5 - Transportation

5.1 - TRANSPORT CONFIGURATION



During loading, ensure that :

- The loading ramp can support the machine weight.
- The loading ramp is correctly attached to transport vehicle.
- The loading ramp has sufficient grip surface.
- The transport vehicle must be parked on a level surface and must be secured to prevent rolling away while machine is being loaded or unloaded.

Do not place yourself below or too close to the machine during loading.

The machine must be completely in the stowed configuration :

- Check the platform is completely empty.

To climb the slope, select low driving speed.

If the slope is too steep, use a winch in addition to the low speed drive.

- Lower the boom.
- Ensure that the jib is raised as necessary to give ground clearance when driving the machine onto the loading ramp.
- Drive onto the truck bed slowly.
- Secure the machine to the tie down points provided (Section D : 5.2 - Machine layout).
- Lock the turntable with the rotation stop pin located under the turntable before transporting (Section D : 5.2 - Machine layout).
- The platform/basket must be chocked and the boom strapped to prevent bouncing up and down, thus preventing possible material damage during transporting.
- Do not use excessive downward force when securing boom section and the basket handrails. Take measures to not damage the extending track.

D - Operation instructions

5.2 - MACHINE STOWAGE FOR TRANSPORT - HA20 LE - HA20 LE PRO HA61 LE - HA61 LE PRO

Turntable rotation pin - Locked



Turntable rotation pin - Unlocked



A

B

C

D

E

F

G

H

I

D

- Operation instructions

Machine stowing

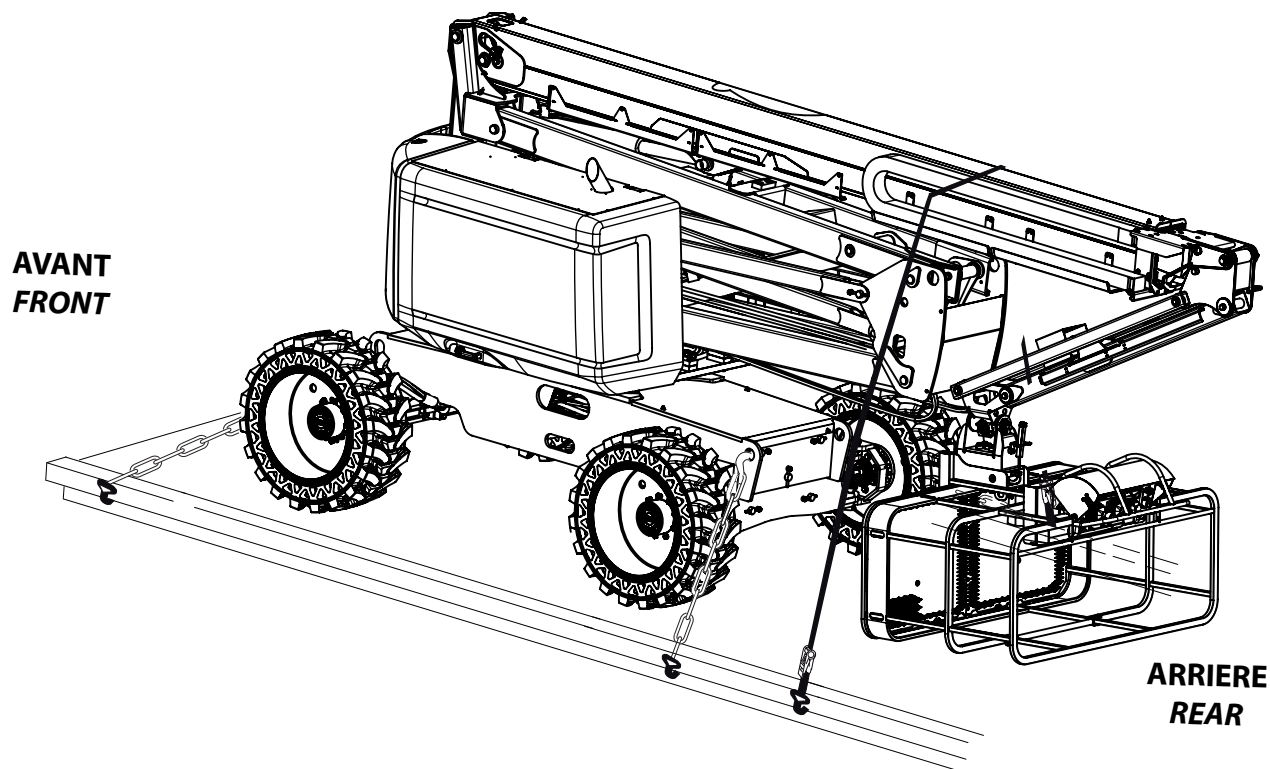

N.B.:- Secure turntable with the turntable locking pin before traveling long distances or hauling machine on a truck.

5.3 - UNLOADING

Before unloading, check that the machine is in good condition.

- Place the turntable rotation locking pin in the disengaged position (Section D : 5.2 - Machine layout).
- Remove the tie downs.
- Select the "going up or down a ramp" speed  at the platform control box.
- Start the machine from platform control box.



Warning : Upon starting a machine that has been secured and transported, the safety system may detect a false overload preventing all movement from the platform control box.

To reinstate the system, lift the jib a few centimetres (inches) using the ground control box.

D - Operation instructions

5.4 - TOWING



In the event of a machine breakdown, the machine can be towed a short distance to load it onto a transport vehicle :

- Ensure that no one is in the platform during towing.
- Ensure boom is in the stowed position and the turntable is locked, prior to towing.
- The platform must be empty.

To tow a broken-down machine, disconnect the wheel drive hubs.

Perform this operation on flat ground with wheels chocked.

In the towing configuration, the machine braking system is inactive. Use a drawbar to avoid any risk of accident :

- Do not exceed the maximum speed (machine unfolded) (Refer to  Section B 4.1 - Technical specifications).
- Do not use on a slope with a gradient greater than 45%.

5.4.1 - Disengaging the drive hubs

- Use an 11 spanner to undo and remove the 2 screws from the plate.



- Remove the plate, turn it over and install it in place with the 2 screws removed previously.

N.B.:-The plate boss will push the spring in. The drive hubs are now disengaged.



D

- Operation instructions



When drive hubs are disengaged, the machine is in free wheel mode and the brake system no longer functions.

5.4.2 - Re-engaging the drive hubs

- To return machine to normal operation and braking, reverse the steps performed in disengaging the drive hubs.



Carry out a few driving movements. The drive hubs are now re-engaged.

Machine is now in the normal driving mode.

D - Operation instructions

5.5 - STORAGE

 The machine can be stored in a designated area when not in use. If it is stored for more than 3 months without being used, an inspection must be carried out before it is put back into service.

 For engine storage condition follow engine supplier operator and maintenance manuals.

 Keep the batteries charged  Section D 7.4 -Optimise battery life.

Machine must be parked in a protected/designated area with the boom in a stowed configuration, however the boom can be raised but must not be extended. Make sure there is no load in the platform.

The batteries self-discharge. The higher the temperature, the quicker the batteries discharge. It is advisable to recharge the battery every month if the machine has been stored and not used.

If the machine is to be stored for more than 72 hours :

- Switch off the ignition and remove the ignition key.



D - Operation instructions

- Connect the machine to the mains supply for the entire storage period.
- Otherwise :
- Disconnect the plug from the power circuit (located under the rear centre cover).

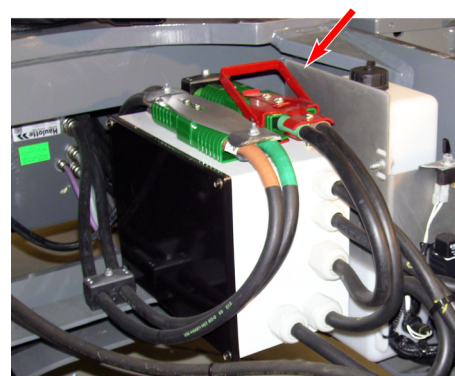

Do not store or immobilise the machine when it is unfolded.

Ensure all access panels, doors and side compartment covers are shut and secured.

Turn the control box activation key switch (21) at the ground control box to the extreme left  to shut OFF the power.

Ensure that the turntable rotation locking pin is shifted to the disabled position (Refer to  Section D 5.2 - Machine layout).

Remove the ignition key to prevent unauthorized operation of the machine.



Storing of the machine with an obstacle under the boom structure is forbidden.



To avoid any risk of corrosion on rods of cylinders during a storage period of more than 1 month :

- In a normal atmospheric environment : perform a complete cycle for the cylinders every 2 months while they are in storage.
- In harsh environments (high levels of salinity in the atmosphere: close to the sea, industrial environment with chloride emissions and/or humidity >70%), we recommend applying the following protection process :
 - Wash and rinse the entire machine with plenty of clean water.
 - Dry all the cylinder rods using an air gun.
 - Apply a solvent-based oil leaving an oily film after evaporation of the solvent directly to all rods left exposed when the machine is in storage position.
 - Re-apply the product every month.



After washing the machine, make sure it is fully air-dry and does not contain moisture on corrosive parts (cylinders rods for example).

Do not wash any electrical components, particularly with high pressure washer. Wipe away dirt from around electrical components with a dry cloth.

D - Operation instructions

5.6 - LIFTING OPERATION

During loading / unloading operation with an overhead crane, it is important to respect the following :

- Put the machine in stowed position, boom and arm fully retracted and lowered.
- Platform must be empty.
- Rotate the turret and the jib to the configuration in the photos below.
- Lock the turret with turret locking pin.
- Verify that lifting attachments are in good operating condition and match the technical specifications. Lifting devices must be attached only to the designated lifting eyes.
- Each of the slings used for lifting the machine must be adjusted to keep the machine level and to minimize the risk of damage to the machine.

- Anchorage point for lifting are identified / labeled by the following symbol .
- ONLY trained and authorized personnel should attempt to lift the machine.



Never lift the machine with slings attached to counterweight.

Procedure for the use of slings



	Number of shackles	Number of slings	Length	Maximum load per sling and shackle
A	4	4	5 m (16 ft 5 in)	3060 kgf (6745 lbf)

D

- Operation instructions

6 - Cold Weather Recommendations

In cold weather, do not store the machine with discharged batteries. It is recommended that, at a temperature below 0 °C(32 °F) , the machine not be stored with a battery charge of below 75 %. If you don't have a power outlet, start the engine in Forced Mode with the generator, to increase the battery's state of charge.

Set to Manual mode to start the engine to check that it is operating correctly. If the engine does not start, do not keep trying for a prolonged period of time. Allow the starter to cool down for a few minutes before trying again. If the engine still does not start after several attempts, consult the maintenance manual and switch to Full Electric mode.

In extreme cold conditions, machines should be equipped with optional cold start kits.

N.B.:-Initial starting should always be performed from the ground control box.

6.1 - ENGINE OIL

The correct SAE viscosity grade of oil is determined by the minimum ambient temperature during cold engine start-up, and the maximum ambient temperature during engine operation.

Generally, use the highest viscosity oil that is available to meet the requirement for the temperature at start-up.

Viscosity index	Engine oil viscosity	
	Minimum	Maximum
SAE 0W20	-40°C (-40°F)	10°C (50°F)
SAE 0W30	-40°C (-40°F)	30°C (86°F)
SAE 0W40	-40°C (-40°F)	40°C (104°F)
SAE 5W30	-30°C (-22°F)	30°C (86°F)
SAE 5W40	-30°C (-22°F)	40°C (104°F)
SAE 10W30	-20°C (-4°F)	40°C (104°F)
SAE 15W40	-10°C (14°F)	50°C (122°F)

Classification API

Fuel type	Engine oil classification
High sulfur fuel ≤ [0.05% (500 ppm)] Sulfur content < 0.50% (5000 ppm)	API CJ-4 or CK-4 (If the engine oil is used with a high sulfur level, change the engine oil at shorter intervals, approximately half)

N.B.:-For additional engine oil recommendations, refer to the engine manual provided with the machine.

D - Operation instructions

6.2 - HYDRAULIC OIL

External environmental conditions can reduce performance of the machine if the hydraulic oil temperature does not reach its optimum range.

It is recommended to use the hydraulic oil according to weather condition. Refer to the table below.

Environmental conditions	SAE Viscosity grade
Ambient temperature between - 15°C (5°F) and + 40°C (+ 104°F)	HV 46
Ambient temperature between - 35°C (- 31°F) and + 35°C (+ 95°F)	HV 32
Ambient temperature between 0°C (+ 32°F) and + 45°C (+ 113°F)	HV 68

N.B.: -It is recommended to replace low temperature oil as the ambient temperature reaches + 15°C (59°F). It is not advisable to mix oils of different brands or types.

D - Operation instructions

7 - Battery care and maintenance

7.1 - BATTERY RECHARGE

7.1.1 - On-board charger

The on-board charger is used to charge the semi-drive batteries. The charger's power is 3000W and the maximum intensity is 16A for 220V - 240V and 110V networks. Battery charging starts as soon as it is connected via the mains supply.

N.B.:-No movements are allowed during batteries charging cycle and while connected to an external power outlet.

Battery charger	80V / 40A
Electric power supply	85-265 Vac / 50-60hz / 16A
Battery voltage	72V
Charging time	Between 12 h and 24 h

Locations

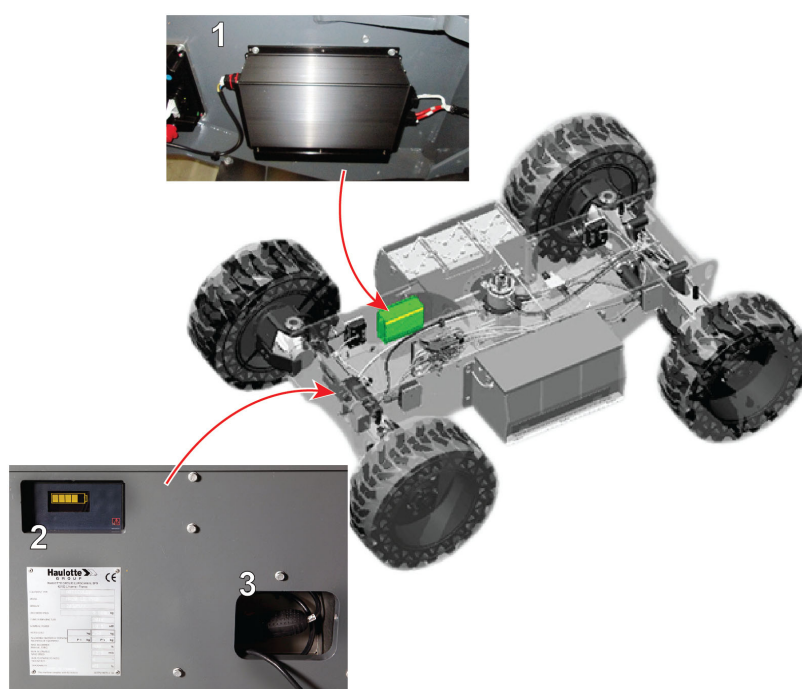

Marking	Description
1	On-board charger
2	Battery charge indicator
3	Battery charger



Never replace the charging cable without written permission from HAULOTTE®.

D - Operation instructions

7.1.2 - Battery charging



- Do not use an external charger or jump the batteries.
- Ensure the mains supply is compatible ;
- Do not use a cable reel with the cable wound up.
- The cable cross-section must be at least 2,5 mm².
- The socket must be able to deliver a current of 16 A.
- If power of the supply is not great enough, a limited charge power can be selected from the Activ'Screen screen (Accessible with level 1 code).

Machine settings / Machine configuration / Option setting / Battery charge configuration /

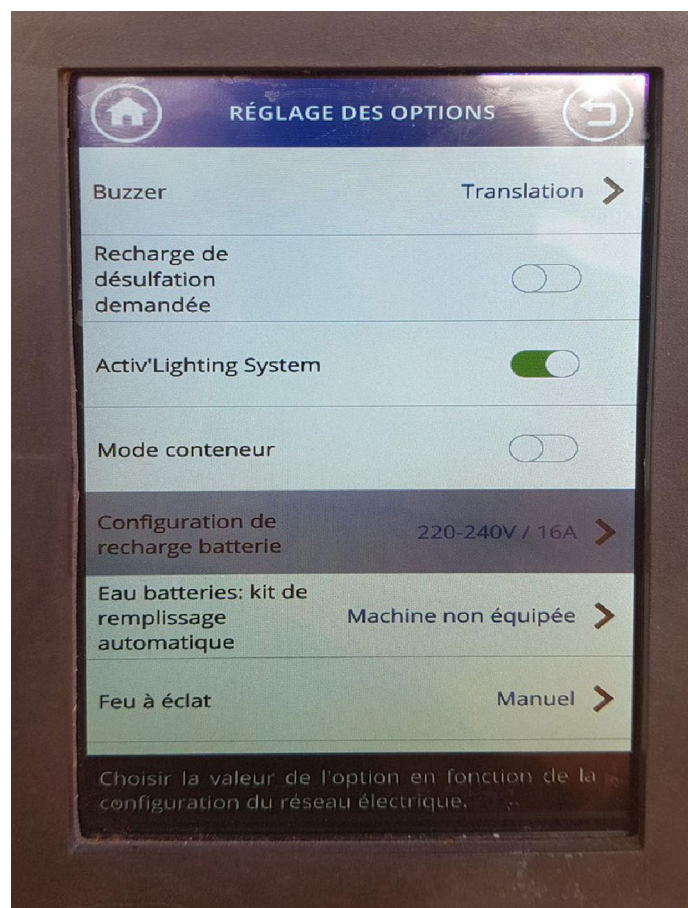

D - Operation instructions

Machine settings / Machine configuration / Option setting / Battery charge configuration /

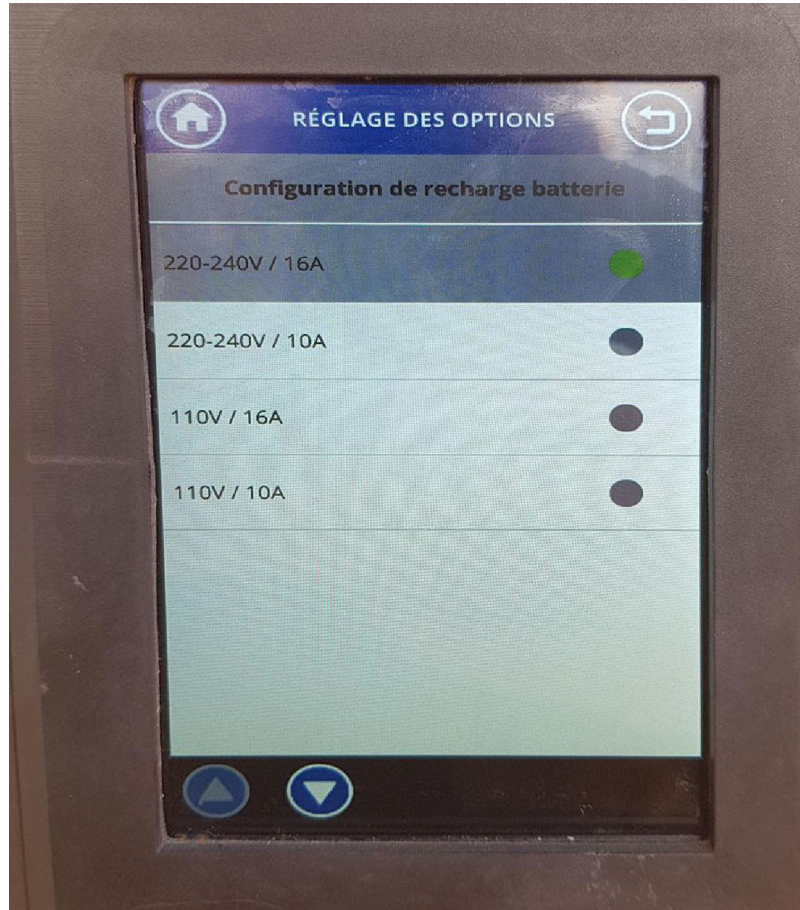

- **ALWAYS** charge batteries in open, well-ventilated areas.
- You are advised to fully charge the battery at least 1 time every 7 days. If this is not done, a reminder will appear on the Activ'Screen screen of the ground control box.

D - Operation instructions

Duration of charge cycle :



- 12 hours approximately, on 220 - 240 V AC network.
- 20 hours approximately, on 110 V AC network.

The charge cycle stops automatically when charging is complete.

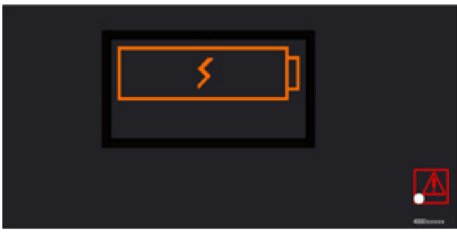
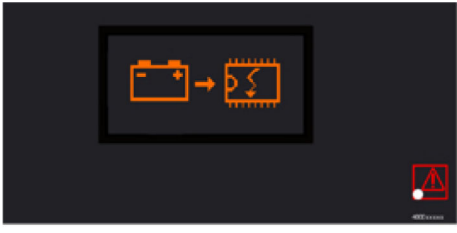
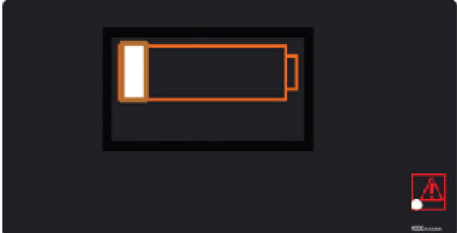
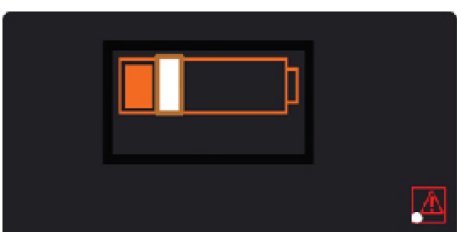
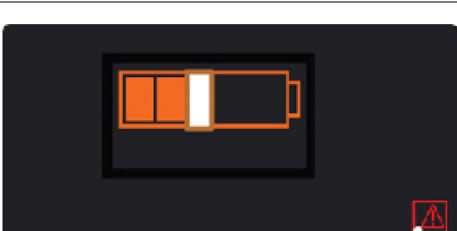
It can take up to 24 hours for a full charge if the battery levels are very low (Charge status less than 5 %).

Charging is going to start		
Internal parameter problem		Disconnect the mains plug. Switch the machine on and off then restart charging.
The first segment flashes		Charge from 0 % to 20 %
The second segment flashes		Charge from 20 % to 40 %
The third segment flashes		Charge from 40 % to 60 %

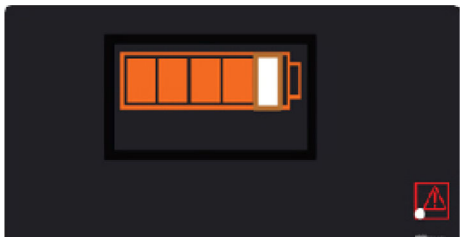
D - Operation instructions

<p>The fourth segment flashes</p>	 <p>The image shows a battery icon on a dark screen. The battery is represented by five segments. The fourth segment from the left is highlighted with a white border and is flashing. A red warning triangle icon is visible in the bottom right corner of the screen.</p>	<p>Charge from 60 % to 80 %</p>
<p>The fifth segment flashes</p>	 <p>The image shows a battery icon on a dark screen. The battery is represented by five segments. The fifth segment from the left is highlighted with a white border and is flashing. A red warning triangle icon is visible in the bottom right corner of the screen.</p>	<p>Charge from 80 % to 100 %</p>
<p>The segments are not flashing</p>	 <p>The image shows a battery icon on a dark screen. The battery is represented by five segments, all of which are lit up in orange. A red warning triangle icon is visible in the bottom right corner of the screen.</p>	<p>100 %</p>
<p>Charging is complete</p>	 <p>The image shows a battery icon on a dark screen. The battery is represented by five segments, all of which are lit up in orange. Below the battery icon, there is a red unplug icon with an arrow pointing to the right. A red warning triangle icon is visible in the bottom right corner of the screen.</p>	<p>Unplug the charging cable from the machine</p>

D - Operation instructions

7.2 - BATTERY CARE AND MAINTENANCE

7.2.1 - Filling batteries

The procedure described below only applies to open lead acid batteries. 6 V open lead-acid battery blocks are composed of 3 2 V single cells connected together in series. The cells are immersed in an electrolyte composed of 1/3 sulfuric acid and 2/3 deionized water.



The batteries must **ONLY** be filled after charging them fully. Failure to comply with these instructions may lead to the electrolyte overflowing, etc...



The batteries **MUST** be filled when necessary or the batteries may be irreparably damaged. The lead plates oxidize in the air. They must always be covered with electrolyte.



The water level in the batteries cannot be topped up if the temperature is lower than 0° as the distilled or deionized water freezes in the centralized filling system.

Single-Point Watering System

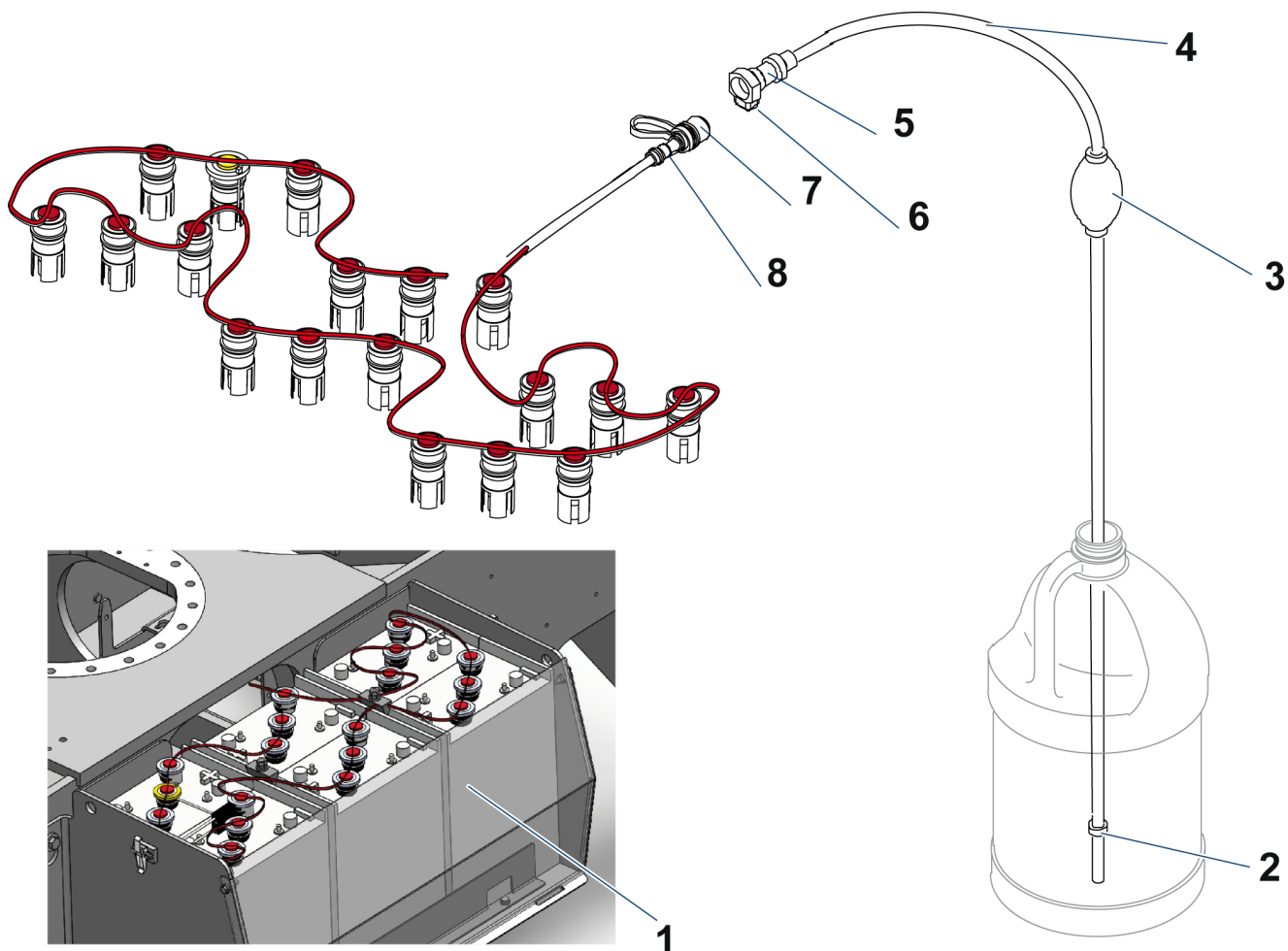

D

 - Operation instructions

Marking	Description
1	Battery
2	Filtered intake
3	Hand pump
4	Hose
5	Female adapter
6	Push-button
7	Dust cover
8	Male adapter

Completely charge the batteries before connecting the distilled-water-filling unit.

D - Operation instructions

7.2.1.1 - Procedure to fill the batteries manually

1. Launch a full charge of the battery and check the charge indicator.
2. Disconnect the batteries charger and put back the plug in its housing.



Levelling of the elements should always be done after charging the batteries. Watering a battery before charge (or with a low charge level) can lead to boil-over, resulting in potential bodily injury and potential damage to the watering system and the battery.

3. Unlock both locks.
4. Remove the rear cover.

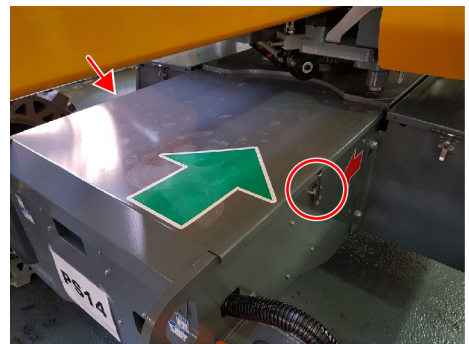

5. Immerse the filtered inlet (2) of the transparent hose (4) fitted with a hand pump (3) in a demineralized water canister (Supplied with the machine).
6. Press the hand pump (3) to prime it until the water rises in the hose (4)

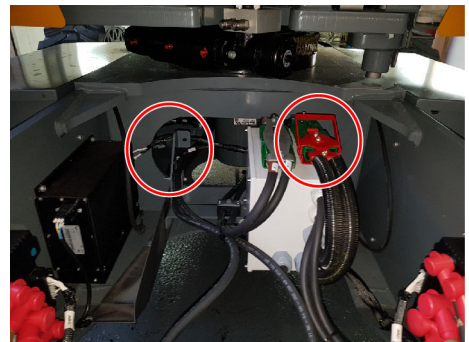

D - Operation instructions

7. Once the hand pump (3) is primed, remove the male connector (8) cap (7) from the black supply tube assembly
8. Connect the female connector (5) quick-hitch from the centralized filling system, including the hand-pump, to the male connector (8).
9. Press firmly on the hand pump to bring the distilled water to the batteries (1).
10. When the bulb (3) becomes resistant, this means that all the battery cells are filled appropriately.
11. Then uncouple the female connector (5) from the male connector (8) filling tube by pressing on the yellow button (6), then replace the cap (7) on the machine hose.
12. Close the machine covers.
13. Do not let the can to connect after filling is finished because this could cause the batteries to overflow.
14. Place the cover in the correct position on the batteries.
15. Unlock both locks on each side of the battery container.

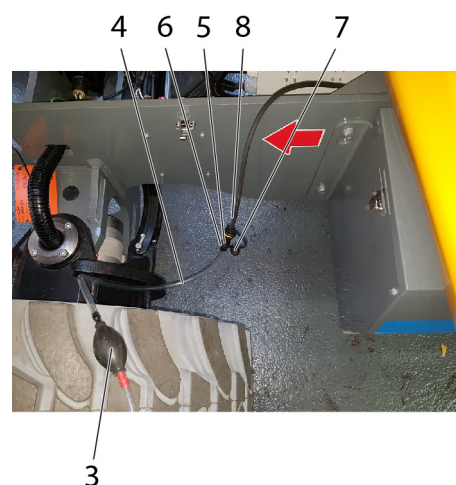

7.2.1.2 - Procedure to fill the batteries automatically - Option

1. Remove the housing.
2. Open the cap.
3. Fill the can with demineralized water.
4. Close the cap properly and reposition the housing.
5. Fully recharge the batteries in order to restart an automatic filling or activate the automatic filling from the Activ'Screen of the ground control box.

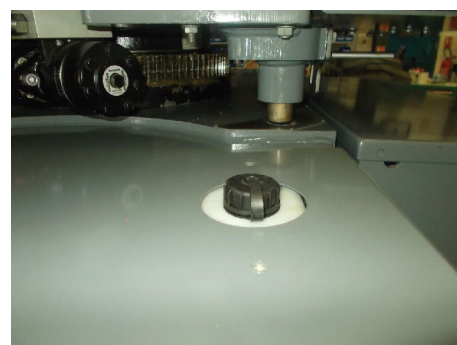
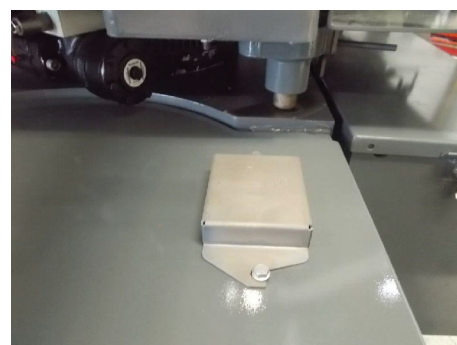

D - Operation instructions

7.2.2 - Desulfation charge

Normal battery use leads to sulfation of the lead plates during discharge (Formation of lead sulfate). Recharging the battery dissolves the lead sulfate. The plates are desulfated.

Moreover, sulfation also appears if the battery self-discharges during storage in a low state-of-charge

A

B

C

D

E

F

G

H

I

E - General Specifications

1 - Machine dimensions

Transport position-Configuration that takes the minimum floor space necessary for storage and / or delivery of the machine

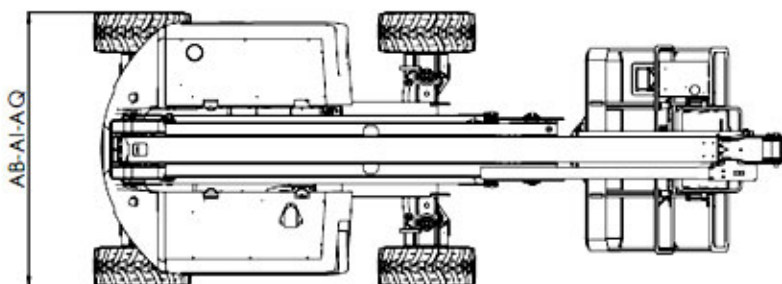
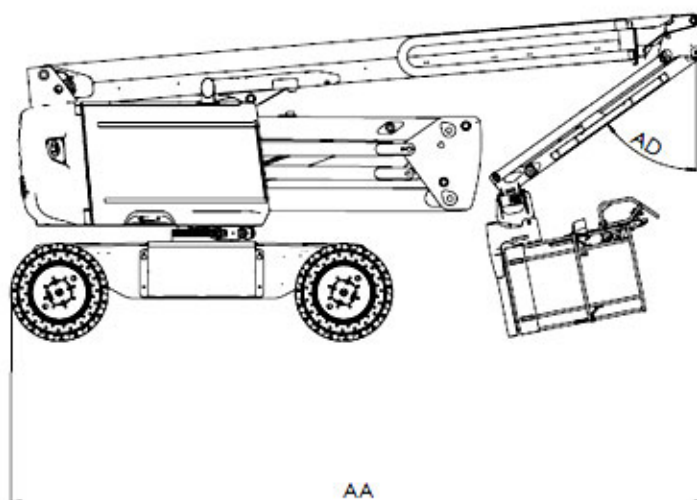
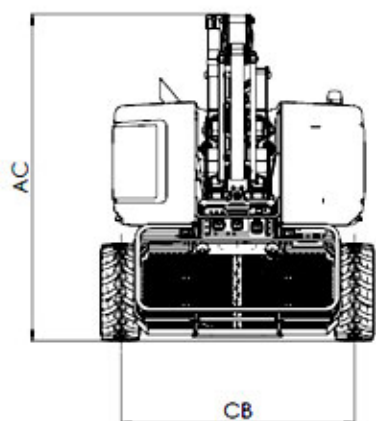

E - General Specifications

Access position

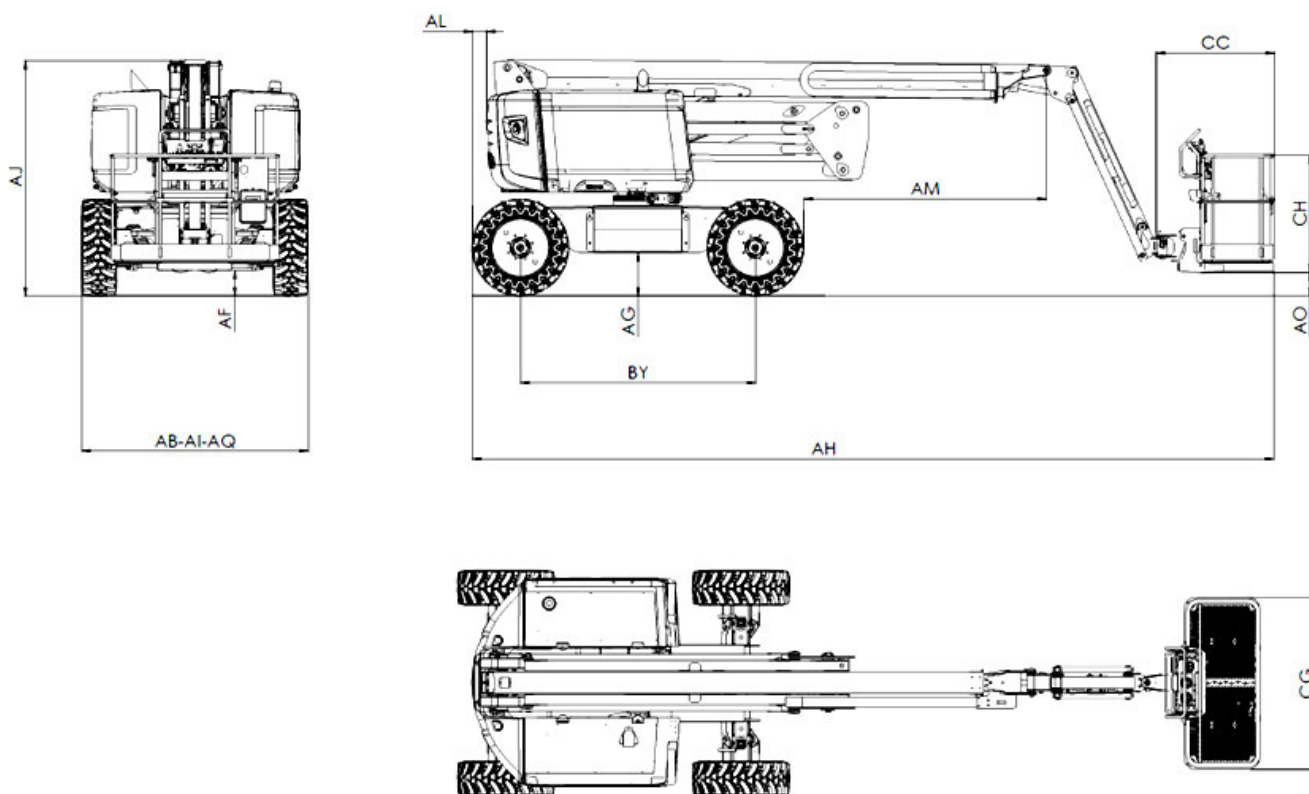

Machine dimensions

Machine		HA20 LE — HA61 LE		HA20 LE PRO — HA61 LE PRO	
Marking	Specifications - Dimensions	SI	Imp.	SI	Imp.
AA	Overall length of the machine in folded / stowed position	6,03 m	19 ft 9 in	6,11 m	20 ft 1 in
AB	Overall width of the machine in folded / stowed position	2,41 m	7 ft 11 in	2,41 m	7 ft 11 in
AC	Overall height of the machine in folded / stowed position	2,98 m	9 ft 9 in	3,06 m	10 ft 0 in
AD	Horizontal articulation angle of the jib to obtain the folded position	70°			
AF	Minimum ground clearance	18 cm	0 ft 7 in	26 cm	0 ft 11 in
AG	Maximum ground clearance	37,3 cm	0 ft 15 in	44,5 cm	0 ft 18 in
AH	Overall length of the machine in access position	8,54 m	28 ft 0 in	8,54 m	28 ft 0 in
AJ	Overall length of the machine in access position	2,42 m	7 ft 11 in	2,50 m	8 ft 2 in
AM	Lateral tail swing according to frame dimension	2,595 m	8 ft 6 in	2,595 m	8 ft 6 in
AO	Platform ground clearance in access position	40 cm	0 ft 16 in	40 cm	0 ft 16 in
BY	Wheel base	2,50 m	8 ft 2.5 in	2,50 m	8 ft 2.5 in
CB	Wheel track	2,06 m	6 ft 9 in	2,04 m	6 ft 8 in
CC	Overall platform length	80 cm	0 ft 32 in	80 cm	0 ft 32 in
CG	Overall platform width	1,83 m	6 ft 0 in	1,83 m	6 ft 0 in
CH	Basket/platform height from the floor to the upper railing	1,188 m	3 ft 11 in	1,188 m	3 ft 11 in

E - General Specifications

2 - Center of gravity

General diagram HA20 LE - HA20 LE PRO – stowed position

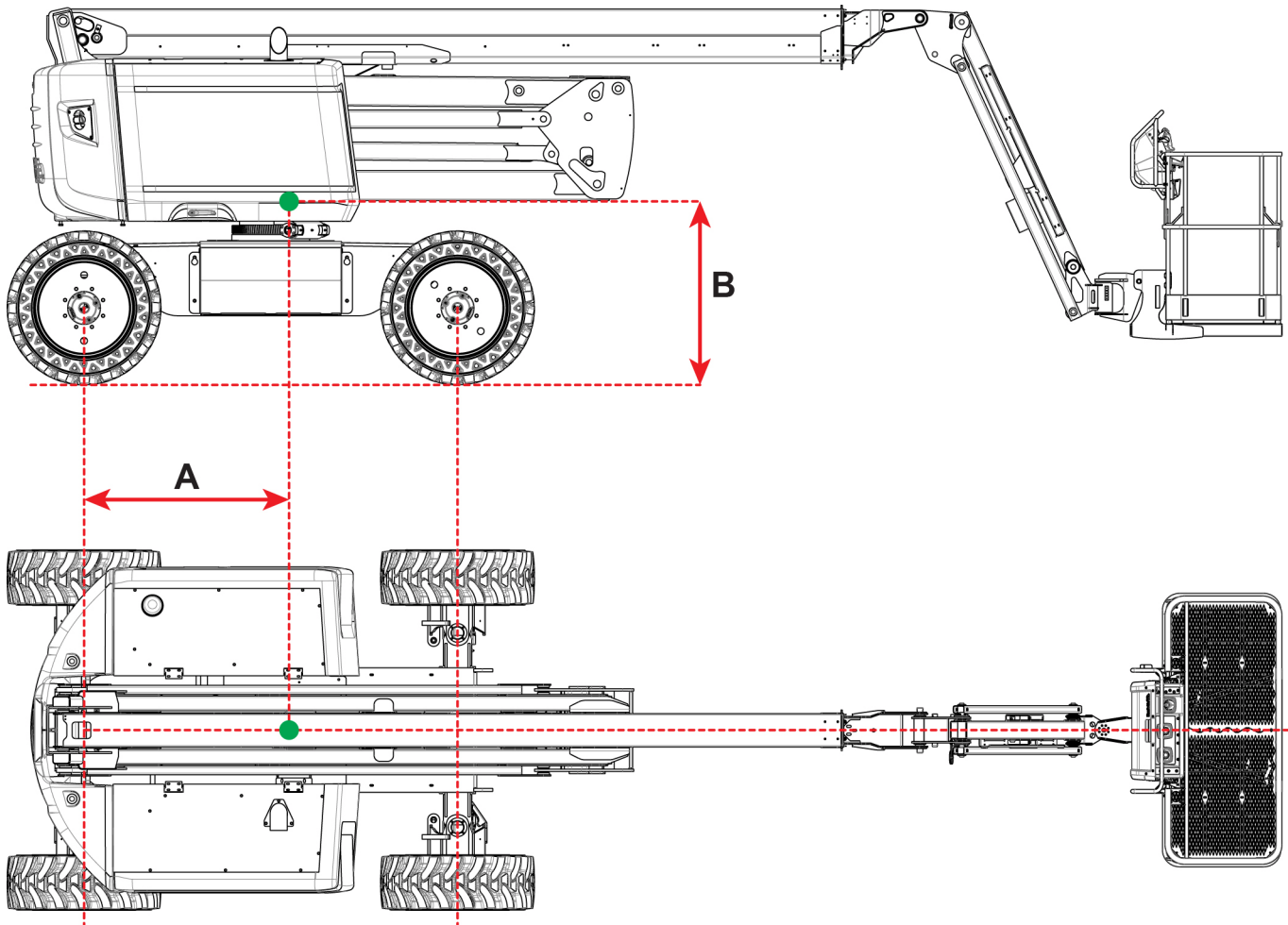

Center of gravity on large wheels-Wheel diameter 1025 mm (40 in)

Coordinates of the machine's center of gravity		stowed position		Drive position	
SI	Imp.	SI	Imp.		
A	1372 mm	54 in	1403 mm	55 in	
B	1228 mm	48 in	1273 mm	50 in	

Center of gravity on small wheels-Wheel diameter 856 mm (34 in)

Coordinates of the machine's center of gravity		stowed position		Drive position	
SI	Imp.	SI	Imp.		
A	1373 mm	54 in	1406 mm	55 in	
B	1175 mm	46 in	1222 mm	48 in	

E - General Specifications

3 - Major component masses

N.B.-:Masses measured with empty tanks.

Component	HA20 LE - HA61 LE		HA20 LE PRO - HA61 LE PRO	
	SI	Imp.	SI	Imp.
Specifications - Dimensions				
Frame assembly mass + Battery+ Axles + Wheels	3466 kg	7640 lbs	3923 kg	8650 lbs
• Mass of each wheel 850 x 340	187kg +/- 4 kg	410 lb +/- 10 lb	NA	
• Mass of each wheel 1025 x 365	NA		290 kg +/- 6 kg	640 lb +/- 15 lb
Turret assembly mass	1369 kg	3020 lbs	1369 kg	3020 lbs
Counterweight assembly mass	1450 kg	3200 lbs	1450 kg	3200 lbs
Engine assembly mass	355 kg	785 lbs	355 kg	785 lbs
Boom assembly mass	821 kg	1810 lbs	821 kg	1810 lbs
Arm assembly mass	1533 kg	3380 lbs	1533 kg	3380 lbs
Jib assembly mass	151 kg	335 lbs	151 kg	335 lbs
Basket assembly mass	182 kg	400 lbs	182 kg	400 lbs
Machine mass	9354 kg	20,625 lbs	9811 kg	21,630 lbs

4 - Acoustics and vibrations

The acoustics and vibrations specifications are based upon the following conditions :

- The airborne noise emissions at workstation are determined per European Directive 2006/42/CE.
- The guaranteed sound power level LWA (displayed on the product) is determined per European Directive 2000/14/CE.
- The vibrations transmitted by the machinery to the hand/arm system and to the whole body are determined per European Directive 2006/42/CE.

	Specifications	
	In thermal mode	In Full Electric mode
Sound pressure level at workstation	73 dBA (+/- 2 dBA)	59 dBA (+/- 2 dBA)
Guaranteed sound power level	99 dBA	
Vibrations hand/arm	Vibration transmitted by this MEWP to the hand-arm does not exceed 2,5 m/s ² (98,4 in/s ²)	
Vibrations whole body	Vibration transmitted by this MEWP to the whole body does not exceed 0,5 m/s ² (19,6 in/s ²)	

E - General Specifications

5 - Wheel/Tire assembly

5.1 - TECHNICAL SPECIFICATIONS

Component	Standard wheel HA20 LE — HA61 LE	Standard wheel HA20 LE PRO — HA61 LE PRO
Reference number	Solideal 850 x 340	Solideal 1025 x 365
Type	Solid Tire (Curred - on)	
Wheel mass	187 kg +/- 4 kg (410 lbs +/- 10 lbs)	290 kg +/- 6 kg (640 lbs +/- 15 lbs)
Size	850 mm / 340 mm — 2 ft 10 in / 1 ft 1 in	1025 mm / 365 mm — 3 ft 5 in / 1 ft 2 in
Torque	320 Nm (236 ft lbs)	

5.2 - INSPECTION AND MAINTENANCE



The tire and rim are bonded together, both must be replaced if either is damaged.

Wheels replacement must be made in the following cases :

- Deformation or cracks on the rim.
- De-bonding between the interface of the steel and the rubber.
- Uniform wear to the wearing line :
 - 850 x 340 wheel : \varnothing 789 mm / 32 in
 - 1025 x 365 wheel : \varnothing 962 / 38 in
- Non-linear wearing of the tread profile (> 10%)

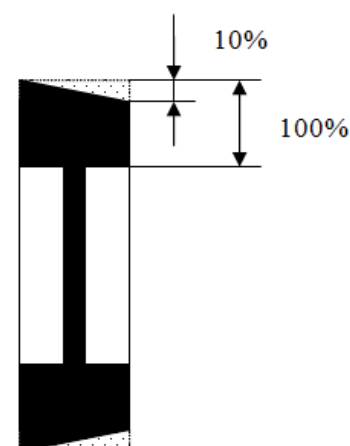

E - General Specifications

- Linear wear of the tread profile (> 25 %)

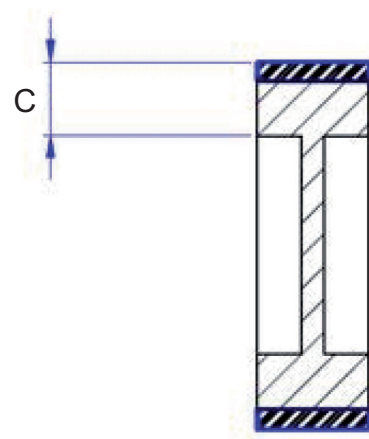

	Standard wheel HA20 LE	Standard wheel HA20 LE PRO
New tire	C = 185 mm / 8 in	C = 168 mm / 7 in
Defective tire (Linear wear of the tread profile > 25 %)	C = 140 mm / 6 in	C = 126 mm / 5 in

- 1 wheel stud is completely torn.
- 2 successive wheel studs are partially torn.
- 2 aperture holes are cut.



Tires and rims are critical components for the stability of the machine. For safety reasons :

- Use only HAULOTTE® spare parts according to the technical characteristics of the machine. Refer to the spare parts catalog.
- Do not replace factory-installed tires with tires of different specifications or ply rating.
- Never replace a solid (rigid) tire with a foam-filled or a pneumatic (air-filled) tire.

Procedure of replacement :

- Loosen the wheel nuts on the wheel to be removed.
- Raise the machine using a jack or a hoist.
- Remove the wheel nuts.
- Remove the wheel.
- Install the new wheel.
- Lower the machine to the ground.

E - General Specifications

- Tighten the wheel nuts to the recommended torque. Refer to maintenance and repair manuals.

N.B.:-If a wheel has been replaced, observing the axle track pattern check for correct installation.

E - General Specifications

6 - Options

6.1 - PLATFORM

Technical specifications

Type	HA20 LE - HA20 LE PRO - HA61 LE - HA61 LE PRO		Platform entry
Small/standard platform	Platform width	0,8 m - 2 ft 7 in	Swing gate
	Platform length	1,8 m - 5 ft 11 in	
Large platform	Platform width	0,91 m - 3 ft	Swing gate
	Platform length	2,44 m - 8 ft	Sliding bar

Swing gate



Sliding bar



E - General Specifications

6.2 - GLAZIER'S KIT

6.2.1 - Description

This attachment is an assembly designed to transport panels. The assembly comprises of a tray that extends along the length of the floor. The panel(s) should be placed in the tray and secured to the guard rail with a strap (not supplied).

N.B.:- This tray can be used **ONLY** with a side entry platform.

6.2.2 - Characteristics

Component	Characteristics
Maximum capacity	115 kg (220 lbs)
Weight of attachment	10 kg (22 lbs)
Maximum load surface	3 m ² (32 sq.ft)
Maximum allowable height of the panel	1,20 m (3 ft 11 in)
Maximum allowed wind	CE / UKCA / AS : 12,5 ms - 45 km/h - 28 mph ANSI / CSA: 7 ms - 25 km/h - 15 mph

6.2.3 - Safety precautions



- Please read and assimilate the instructions before using the attachment.
- This attachment is designed for transporting panels. Do not use this attachment for transporting other types of load.
- Do not suspend loads.
- Do not overload the attachment and ensure that the equipment is correctly attached by means of a strap (not supplied).
- Do not exceed the maximum allowable platform capacity. The combined weight of the attachment, the panel(s) , the occupants, the tools and any other equipment must not exceed the maximum allowable platform capacity.
- Do not load panels whose surface area exceeds the maximum authorized surface area. Exposing an additional surface area to the wind reduces machine stability. Do not install any other attachments that increase the surface area exposed to the wind.
- Check that the position of the panel is not reducing visibility during maneuvers in the work environment. Do not transport panels whose height exceeds the authorized limit.
- When maneuvering, ensure that a safe distance is maintained between the panel and the obstacles in the work environment.
- Do not use the machine if the wind speed exceeds the allowable limit with the attachment.

6.2.4 - Pre-operation inspection



- Check that the tray has no cracks or other damage.
- Check that the cradle is correctly installed and secured to the platform.
- Check that the information decal is present on the cradle and is legible.
- Check that the strap is not twisted or torn.

E - General Specifications

6.2.5 - Operation

- Load the panel onto the tray on platform.
- Secure the panel tray on the guardrail by means of a strap (not supplied) with the correct strength and dimensions.

Strapping example(s) - Large panel



Strapping example(s) - Small panel



E - General Specifications

6.2.6 - Assembly / Dis-assembly

Tray

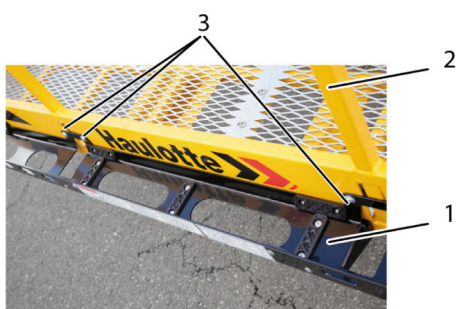

Marking	Description
1	Tray (Panel carrier)
2	Platform
3	Screws and nuts
4	Collars COLSON
5	Plastic protection

- Fix the tray (1) to the platform (2) using screws and bolts (3)
- Install plastic protection (5) on the handrail and attach it using collars (4)

N.B.:-Torque Requirements : 22 Nm (15 ft lbs)

- Pre-operation test : Place a load of 176 kg (390 lbs) on the carrier and carry out an inspection. Refer to the chapter on pre-operation inspection.

E - General Specifications

6.2.7 - Specific decals

Location of the decals

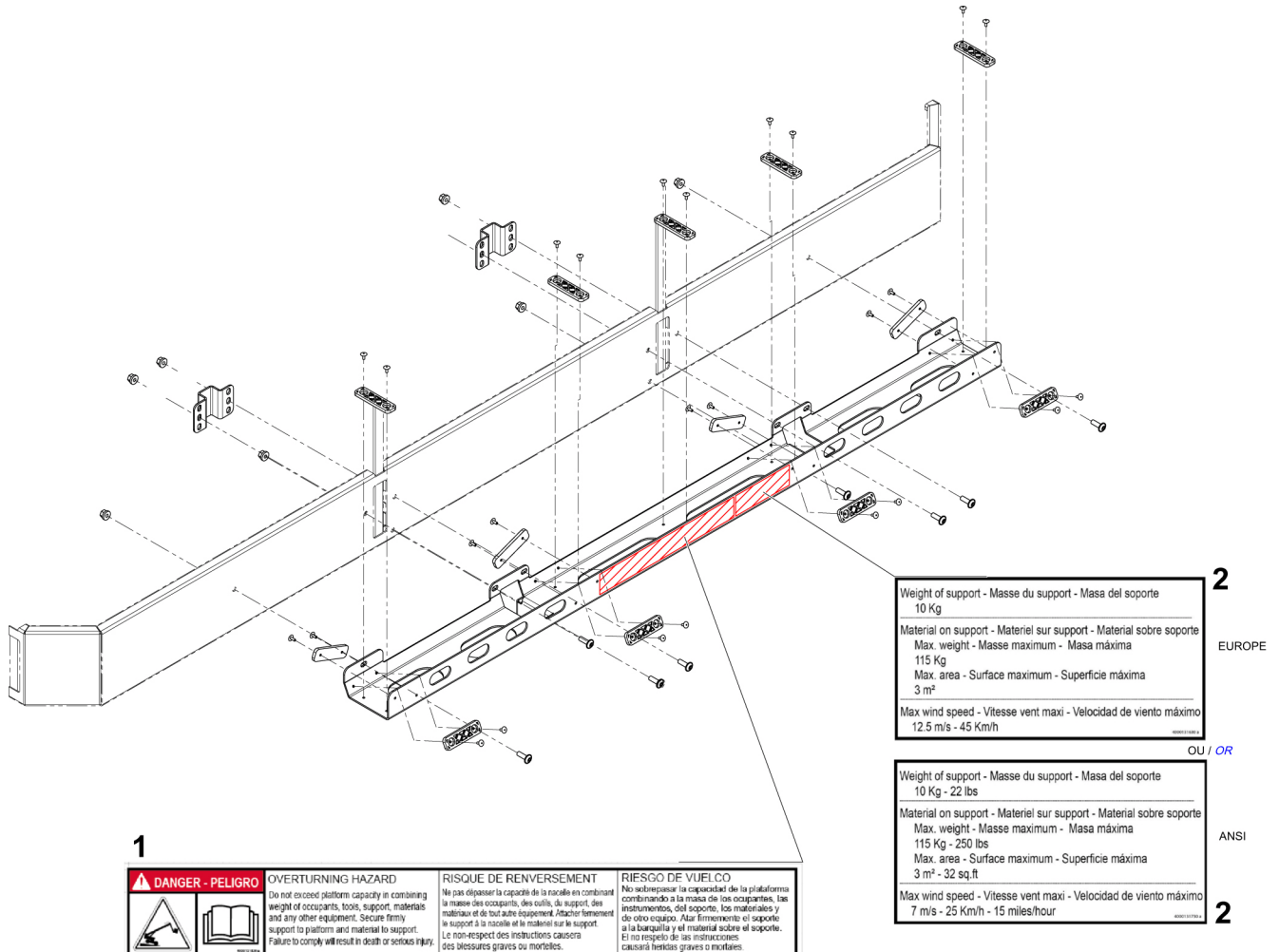

1

	OVERTURNING HAZARD Do not exceed platform capacity in combining weight of occupants, tools, support, materials and any other equipment. Secure firmly support to platform and material to support. Failure to comply will result in death or serious injury.	RISQUE DE RENVERSEMENT Ne pas dépasser la capacité de la nacelle en combinant la masse des occupants, des outils, du support, des matériaux et de tout autre équipement. Attacher fermement le support à la nacelle et le matériel sur le support. Le non-respect des instructions causera des blessures graves ou mortelles.	RIESGO DE VUELCO No sobrepasar la capacidad de la plataforma combinando a la masa de los ocupantes, los instrumentos, del soporte, los materiales y de otro equipo. Atar firmemente el soporte a la barquilla y el material sobre el soporte. El no-respeto de las instrucciones causará heridas graves o mortales.
--	--	---	---

2

Weight of support - Masse du support - Masa del soporte 10 Kg	EUROPE
Material on support - Materiel sur support - Material sobre soporte Max. weight - Masse maximum - Masa máxima 115 Kg Max. area - Surface maximum - Superficie máxima 3 m ²	
Max wind speed - Vitesse vent maxi - Velocidad de viento máximo 12.5 m/s - 45 Km/h	
OU / OR	

2

Weight of support - Masse du support - Masa del soporte 10 Kg - 22 lbs	ANSI
Material on support - Materiel sur support - Material sobre soporte Max. weight - Masse maximum - Masa máxima 115 Kg - 250 lbs Max. area - Surface maximum - Superficie máxima 3 m ² - 32 sq.ft	
Max wind speed - Vitesse vent maxi - Velocidad de viento máximo 7 m/s - 25 Km/h - 15 miles/hour	

Marking	Description	Quantity	Part number
1	Risk of overturning	1	40000131830
2	Equipment characteristics	1	CE / UKCA / AS : 4000131630 ANSI / CSA: 4000131730

E - General Specifications

6.3 - PLUMBER'S KIT

6.3.1 - Description

This attachment is an assembly designed to transport pipes and tubes. The assembly comprises of 2 cradles securely attached to the platform. The load (material) should be placed in both the cradles and secured with a strap (not supplied).

6.3.2 - Characteristics

Component	Characteristics
Weight of the carrier	8 kg (20 lbs)
Weight of the equipment on the carrier	80 kg (175 lbs)
Maximum load surface	0,8 m ² (Ø 0,32 m x 2,5 m) / 8.6 sq.ft (Ø 1 ft x 8.6 ft)
Maximum wind speed allowed	12,5 m/s - 45 km/h - 28 mph

6.3.3 - Safety precautions



- Please read and assimilate the instructions before using the attachment.
- This attachment is designed for transporting pipes and tubes. Do not use this attachment for transporting other types of load. .
- Do not suspend loads.
- Do not overload the attachment and ensure that the equipment is correctly attached by means of a strap (not supplied).
- Do not exceed the maximum allowable platform capacity. The combined weight of the attachment, load, the occupants, the tools and any other equipment must not exceed the maximum allowable platform capacity.
- Do not load tubes whose surface area exceeds the maximum authorized surface area. Exposing an additional surface area to the wind reduces machine stability. Do not install any other attachments that increase the surface area exposed to the wind.
- Do not use the machine if the wind speed exceeds the authorized limit of the attachment.
- The cradles should always be positioned such that they are within the platform. Position the bottom end of the cradles such that they are resting on the platform floor.
- When maneuvering, ensure you maintain a safe distance between the load and the obstacles in the work environment.

6.3.4 - Pre-operation inspection



- Check that the cradle has no cracks or other damage.
- Check that the cradle is correctly installed and secured to the platform.
- Check that the information decal is present on the cradle and is legible.
- Check that the strap is not twisted or torn.
- Check that the position of the load and attachment is not obstructing access to the platform or the controls.
- Check that the position of the attachment and the load is not reducing visibility during maneuvers in the work environment.

E - General Specifications

6.3.5 - Operation

- Position the load to rest on the 2 cradles.
- Center the load on the cradles.
- Securely attach the load to each cradle with strap of adequate strength and dimensions.

Strapping example(s)



6.3.6 - Assembly - Dis-assembly

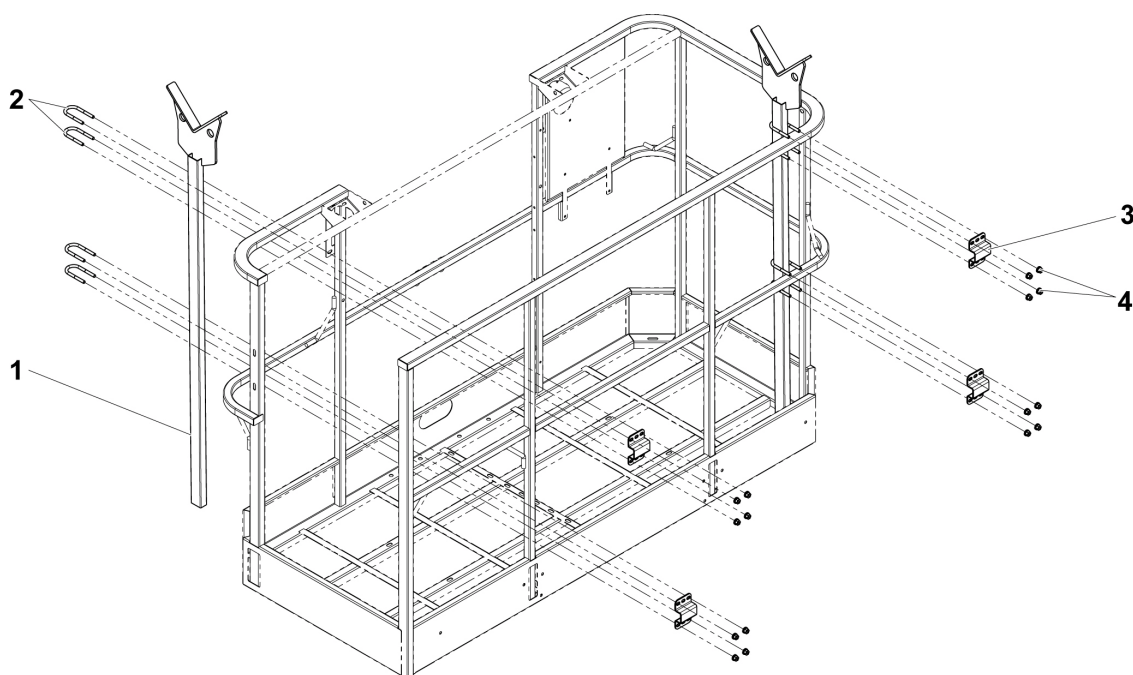

Marking	Description
1	Cradle
2	Fastening screw U bolt
3	Flange
4	Nuts

E - General Specifications

- Locate the cradles such that the load will be parallel to the length of the platform.
- Install two cradles (1) to the guardrails using 4 supplied flanges (3).
- Tighten up the flange using 2 supplied screw U bolts (2) and 4 nuts (4), wherever a cradle and the horizontal guardrail tubes intersect.

N.B.-:Torque Requirements : 22 Nm (15 ft lbs)

- Ensure that the bottom of cradle is resting on the platform floor.
- Ensure that the distance between the 2 cradles support and center the load.
- Pre-operation test : Place and secure the load of 120 kg (265 lbs) on the cradles. Ensure that the cradles can support the load and that there is no visual structural damage.

E - General Specifications

6.3.7 - Specific decals, optional

Location of the decals

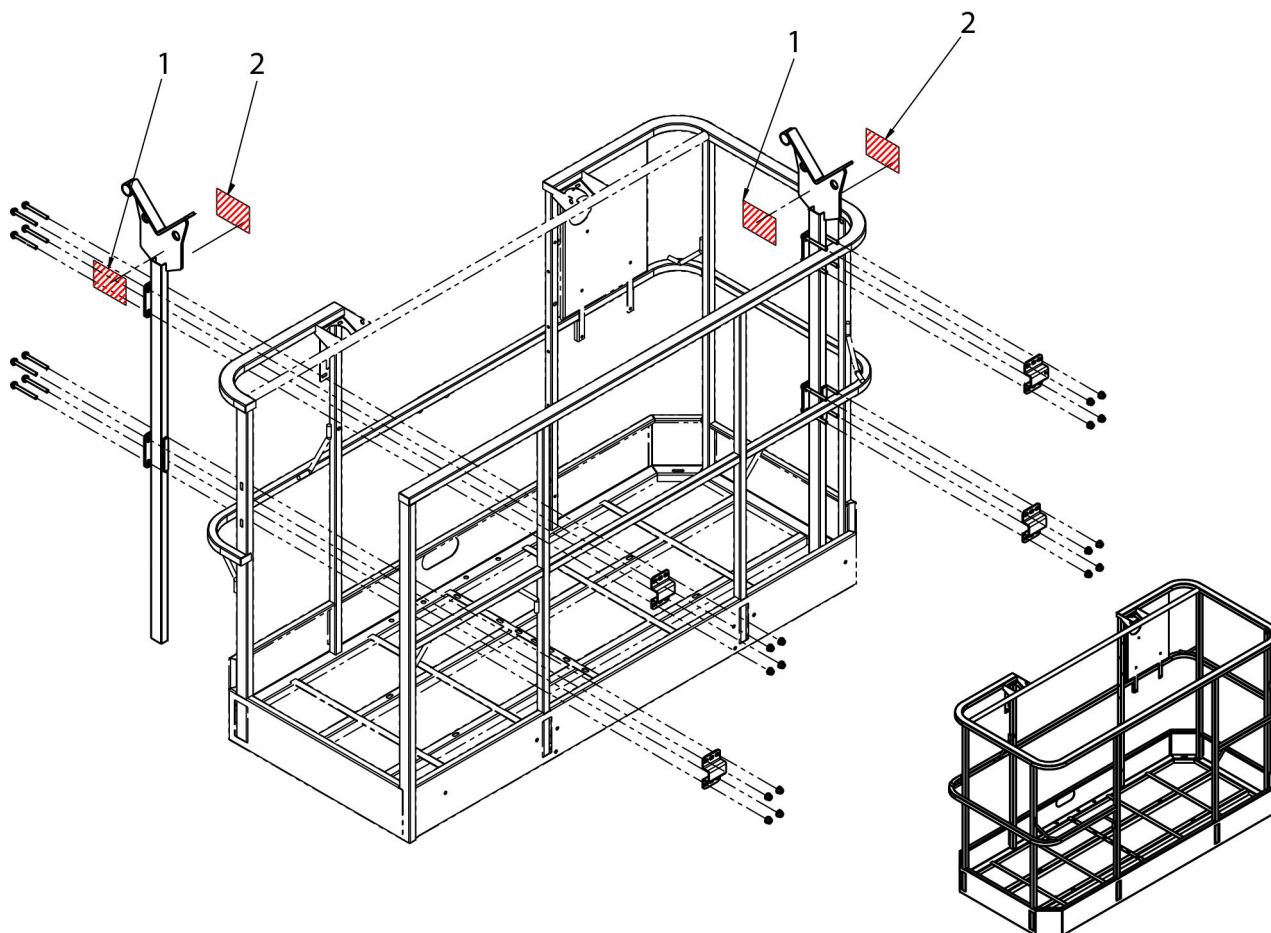

Marking	Description	Quantity	Part number
1	Risk of overturning	2	In english 4000131600 In french 4000131610 In spanish 4000131620 In german 4000708570
2	Equipment characteristics	2	4000131650

E - General Specifications

6.4 - ACTIV' SHIELD BAR - SECONDARY GUARDING SYSTEM (IF FITTED)

6.4.1 - Description



General Specification Activ' Shield Bar :

- The Activ' Shield Bar is a device designed to reduce the risk of entrapment against the control panel when the platform is in confined spaces.
- This device is complementary to the existing operator protection including the enable switch system (Trigger of joystick, Foot Switch and Enable Switch on ground control box).
- The Activ' Shield Bar is active when the platform is elevated (boom or arm) and creep speed is automatically engaged. It is not enabled when stationary or in the transport position, when drive, turret rotation and jib raise are possible.
- The green indicator light of the Activ' Shield Bar is illuminated indicating the device is active :
- Light flashing : Machine stationary in Activ' Shield Bar zone (The platform is elevated and the Activ' Shield Bar will be active during movements).
- Light on : Activ' Shield Bar is active.



This system does not relieve the operator from the responsibilities of learning and practicing the principles of safe use and operation of the machine as provided by the manufacturer's instructions, employer's safety rules and worksite regulations

6.4.2 - Characteristics

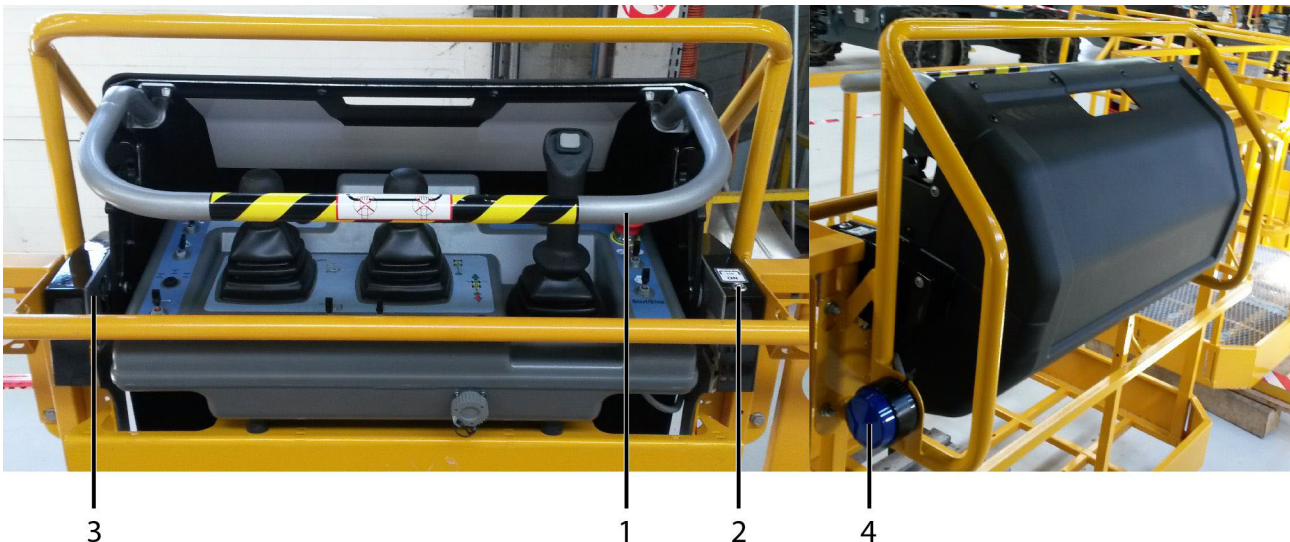

Marking	Description
1	Activation bar
2	Green indicator light
3	Sensor
4	Blue flashing light

E - General Specifications

6.4.3 - Safety precautions



It is mandatory to ensure that the **Activ' Shield Bar** is functional at each start-up of the machine



Do not use the **Activ' Shield Bar** as a handhold. This could result in an inadvertent triggering of the **Activ' Shield Bar**.

- Check the work area for overhead clearances, obstructions or other possible hazards.
- When driving, position the platform so as to provide the best visibility possible and avoid any blind spots.
- Always ensure that the chassis is never driven any closer than 1 m (3 ft3 in) from holes, bumps, tilts, obstructions, debris and ground coverings that may hide dangers.
- During operation, keep all the parts of the body inside the platform.
- To position the machine close to obstacles, it is recommended to use boom movements (arm, boom, etc.) instead of the drive movements.
- Do not drive fast in narrow or cluttered areas. Keep speed under control while making turns or sharp bends.

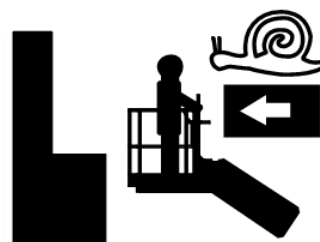
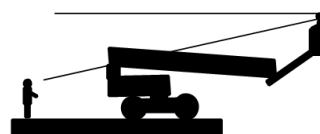

A

B

C

D

E

F

G

H

I

E - General Specifications

6.4.4 - Pre-operation inspection



- If any item on the checklist is marked NO during the inspection; machine must be tagged and locked out and placed out of service.
- DO NOT operate the machine until all identified items are corrected and it has been declared safe for operation.

Description	Yes	No
Perform all specified machine functional tests		
• All machine functional tests result positive		
Start the machine from platform control box		
Switch off (push in) all the emergency stop buttons		
• Check absence of warning signal		
• Check that the blue indicator (4) is not activated when the machine is in stowed position		
To ensure Activ' Shield Bar device is functioning correctly, perform the following :		
When stowed :		
• Check that the green indicator light (2) is not illuminated		
When boom or arm is raised above 15° :		
• Check that the green indicator light (2) is blinking-With platform stationary.		
• Check that the green indicator light (2) is illuminated-With platform in motion.		
Simultaneously make a movement and push forward the activation bar to trigger the system :		
• Check that all movements stop.		
• Check that the horn and the blue flashing light (4) are activated.		

N.B.-:-Press the Foot Switch to reset the system

6.4.5 - Operation

If the Activ' Shield Bar is pushed forward, all movements are stopped. The horn sounds and the warning blue light flashes. Only movements to move away from the entrapment are authorised.

To re-set the Activ' Shield Bar, release the activation bar, the Foot Switch and controls. Then, re-press the Foot Switch.

Care must be taken during all operations to prevent collision and entrapment against structures.

E - General Specifications

6.4.6 - Specific decals

Location of the decals

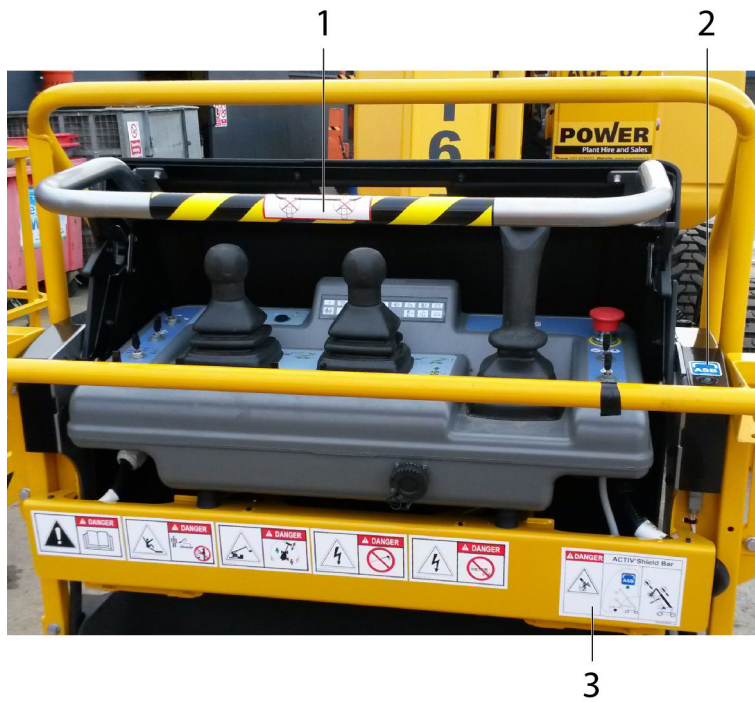

Marking	Description	Quantity	Part number
1	Do not lean on the bar	1	4000206690
2	Activ' Shield Bar controls	1	4000596720
3	Activ' Shield Bar instructions	1	4000609540

Activ' Shield Bar instructions

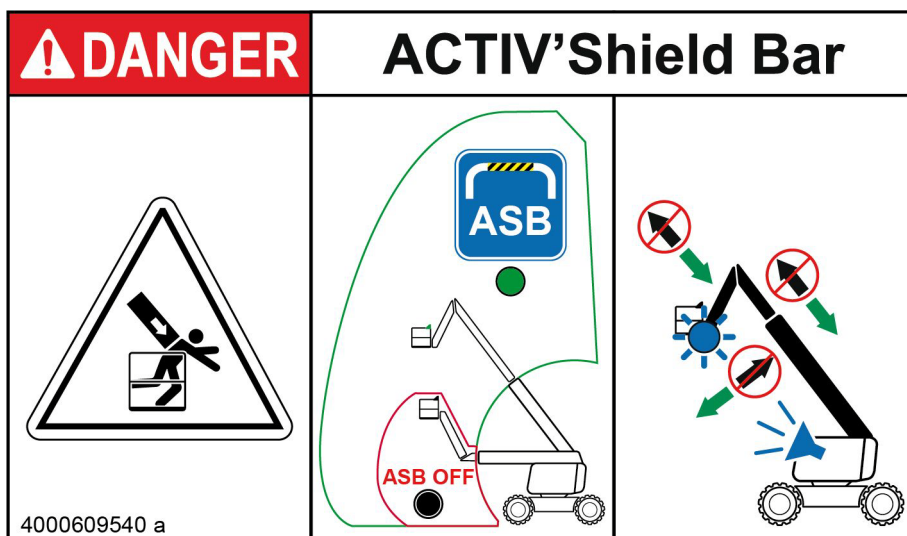

F - Maintenance

1 - General

As an owner and/or operator of Haulotte equipment, your Safety is of utmost importance to HAULOTTE®, which is why HAULOTTE® places such a high priority on product safety.

INSPECTIONS are not only required by HAULOTTE®, but may also be required by industry standards and/or local regulations.

To ensure your equipment continues to achieve the level of performance set in the factory, it is important to maintain it regularly. We remind you that it is strictly forbidden to make any modifications. Regular and timely inspections will reduce equipment down time as well as prevent possible injury.

N.B.-:DO NOT OPERATE unless you are familiar and trained in the principles of safe machine operation.

Overview :

- Walk-around inspections take only a few minutes at the beginning and end of each shift – one of the best ways to prevent mechanical problems and safety hazards.

What to Do :

- Use your senses: sight, smell, hearing and touch.

Frequency :

- Check your machine periodically during your entire workday.
- Make sure to do your inspection the same way every time.
- Complete one of these inspections at the start and end of each shift.

N.B.-:If damage or unauthorized modifications are discovered, the machine must be removed from service until repairs are made by a qualified service technician.

It is the owner's responsibility to ensure the required maintenance as recommended by Haulotte is completed prior to the operation of the machine.

If regular maintenance is not carried out, this may :

- Void the warranty.
- Cause machine malfunction.
- Reduce machine reliability and shorten its service life.
- Jeopardize operator safety.

HAULOTTE Services® technicians are specially trained to carry out extensive repairs, interventions or adjustments on the safety systems or elements of HAULOTTE® machines. They carry genuine HAULOTTE spare parts and tools as required, and also provide fully documented reports on all work completed.

The inspection and maintenance table, identifies the role and the responsibilities of each party in periodical machine maintenance.  Section C 3 - Inspection and Functional test.

F

- Maintenance

2 - Maintenance Schedule

This section provides the necessary information needed to place the machine in safe operation. In accordance with the regulations that are currently applicable, this machine is designed to have a 10 year life span in normal usage conditions. The life may be extended or reduced dependent on the severity of operating conditions, the machine condition itself and by conducting effective inspections and maintenance in addition to other external factors. There are a number of factors which can affect the design life including but not limited to, severity of operating conditions/routine maintenance which should be carried out in accordance with this manual.

Severity of operating conditions may require a reduction in time between maintenance periods. Machines that have been out of service or have not been in use for more than 3 months must undergo a periodic inspection before the machine is put back into service.

Maintenance must be carried out by a competent company or person familiar with mechanical procedures.

Maintenance operations performed must be recorded in a register / log book of the machine.

F

- Maintenance

3 - Inspection program

3.1 - GENERAL PROGRAM

The machine must be inspected on a regular basis at intervals of no less than once 1 per year. The purpose of the inspection is to detect any defect which could lead to an accident during routine use of the machine. Local standards and regulations may require more frequent inspections.

HAULOTTE® requires Reinforced and Major Inspections to be carried out on the product to extend its service life.

Inspections must be carried out by a competent company or person.

The inspection results must be recorded in the safety register or machine log book controlled and overseen by the company manager. This register or machine log book and the list of competent repair persons must be made available to the government work inspector and HAULOTTE Services®.

When	Responsible	Stakeholder	What
Before sale	Owner (or renter)	Competent technician or qualified technician HAULOTTE Services®	Periodic inspection
Before rent	Owner (or renter)	Competent technician or qualified technician HAULOTTE Services®	Daily inspection
Before use or every change of user	User	User	Daily inspection
Annually (1 year)	Owner (or renter)	Competent technician or qualified technician HAULOTTE Services®	Periodic inspection
5 years	Owner (or renter)	Qualified technician HAULOTTE Services®	Reinforced inspection
10 years	Owner (or renter)	Qualified technician HAULOTTE Services®	Major inspection

3.2 - DAILY INSPECTION

The Daily inspection includes a visual inspection, operational checks and testing of the safety systems. This must be conducted by the operator before using the machine.

This inspection is the responsibility of the user. Refer to  Section C 3.1 - Daily inspection.

F

- Maintenance

3.3 - PERIODIC INSPECTION

The Periodic inspection is a thorough evaluation of the operation and safety features of the machine.

It must be conducted before the sale / resale of the machine and/or at least once every year.

Local regulations may have specific requirements on frequency, and content of inspections.

The severity of operating conditions may require frequent inspections.

This inspection is the responsibility of the owner, and inspections must be carried out by a competent company or person.

This inspection is in addition to the daily inspection.

This inspection should also be conducted after :

- Extensive dismantling and reassembly of major components.
- Repairs involving the machine's essential components.
- Any accident causing stress to the machine.

3.4 - REINFORCED INSPECTION

The Reinforced inspection is a thorough evaluation of the machine's structural components, to ensure proper functionality of the machine.

This evaluation must occur at a frequency of 5000 hours or every 5 years.

This inspection is the responsibility of the owner, and it must be conducted by a HAULOTTE Services® technician or by a competent company or person.

This inspection includes :

- Daily inspection
- Periodic inspection

N.B.-:Refer to the Maintenance manual for details.

3.5 - MAJOR INSPECTION

The Major inspection is a thorough evaluation of the machine's integrity and proper functioning; after a normal service life of 10 years.

This evaluation must take place after 10 years of operation and then repeated every 5 years thereafter.

The severity of operating conditions may require frequent inspections.

This inspection is the responsibility of the owner, and it must be conducted by a HAULOTTE Services® technician or by a competent company or person.

This inspection includes :

- Daily inspection
- Periodic inspection
- Reinforced inspection

N.B.-:Refer to the Maintenance manual for details.

F - Maintenance

4 - Repairs and adjustments

Extensive repairs, interventions or adjustments on the safety systems or components must be performed by a HAULOTTE Services® technician. Use original spare parts and components only.

N.B.:-HAULOTTE Services® technicians are trained professionals to perform extensive repairs, interventions and adjustments on the safety systems or components of HAULOTTE® machines. The technician carries genuine HAULOTTE® spare parts and tools as required, and also provides fully documented reports on all work completed.

HAULOTTE Services® will not take responsibility for any outcomes resulting from inferior services or repairs performed by other unauthorised personnel.

HAULOTTE® reminds that NO modifications SHALL be carried out without the written permission of HAULOTTE®.

Any unauthorised repairs/modifications will void HAULOTTE® warranty.

To check for safety campaigns, consult our website : www.haulotte.com



N.B.:-When disposing or scrapping this machine, please consider appropriate methods of recycling. Any items that require specific disposal are listed with instructions in the maintenance manual.

G - Other information

1 - Conditions of warranty

Our warranty conditions and extension contracts are now available on the websites of our sales network : www.haulotte.com







2 - Subsidiary contact information

	<p>HAULOTTE FRANCE PARC DES LUMIERES 601 RUE NICEPHORE NIEPCE 69800 SAINT-PIERRE TECHNICAL Department: +33 (0)820 200 089 SPARE PARTS : +33 (0)820 205 344 FAX : +33 (0)4 72 88 01 43 E-mail : haulottefrance@haulotte.com www.haulotte.fr</p>		<p>HAULOTTE ITALIA VIA LOMBARZIA 15 20098 SAN GIULIANO MILANESE (MI) TEL: +39 02 98 97 01 FAX: +39 02 9897 01 25 E-mail : haulotteitalia@haulotte.com www.haulotte.it</p>		<p>HAULOTTE INDIA Unit No. 1205, 12th floor, Bhumiraj Costarica, Plot No. 1&2, Sector 18, Palm Beach Road, Sanpada, Navi Mumbai- 400 705 Maharashtra, INDIA Tel. : +91 22 66739531 to 35 E-mail : hlindia@haulotte.com www.haulotte.in</p>
	<p>HAULOTTE HUBARBEITSBÜHNEN GmbH Ehrenkirchener Strasse 2 D-79427 ESCHBACH TEL : +49 (0) 7634 50 67 - 0 FAX : +49 (0) 7634 50 67 - 119 E-mail : adv-gmbh@haulotte.com www.haulotte.de</p>		<p>HAULOTTE VOSTOK 61A, bld.1, RYABINOVAYA STREET 121471 MOSCOW RUSSIA TEL/FAX : +7 495 221 53 02 / 03 E-mail : salesrus@haulotte.com www.haulottevostok.ru</p>		<p>HAULOTTE DO BRASIL Av. Alameda Caiapós, 589 CEP: 06460-110 – TAMBORÉ BARUERI – SAO PAULO – BRASIL TEL : +55 11 4196 4300 FAX : +55 11 4196 4316 E-mail : haulottebrasil@haulotte.com www.haulotte.com.br</p>
	<p>HAULOTTE IBERICA C/ARGENTINA Nº 13 - P.I. LA GARENA 28806 ALCALA DE HENARES MADRID TEL : +34 902 886 455 TEL SAT : +34 902 886 444 FAX : +34 911 341 844 E-mail : iberica@haulotte.com www.haulotte.es</p>		<p>HAULOTTE POLSKA Sp. Z.o.o. UL. GRANICZNA 22 05-090 RASZYN - JANKI TEL : +48 22 720 08 80 FAX : +48 22 720 35 06 E-mail : haulottepolska@haulotte.com www.haulotte.pl</p>		<p>HAULOTTE MÉXICO, S.A. de C.V. Calle 40 SUR ESQUINA 13 ESTE No. S/N Colonia CIVAC, JUITEPEC, MORELOS CP 62578 México TEL : +52 77 7321 7923 FAX : +52 77 7516 8234 E-mail : haulotte.mexico@haulotte.com www.haulotte.com.mx</p>
	<p>HAULOTTE in JAPAN SBJ ShinOsaka BLDG 3F 4-6-5 Nishinakajima Yodogawa-ku, Osaka, JAPAN, Post Code: 532-0011 TEL : +81 6 6795 9008 FAX : +81 6 6795 9009 www.haulotte.com</p>		<p>HAULOTTE SINGAPORE Pte Ltd. No.26 CHANGI NORTH WAY, SINGAPORE 498812 Parts and service Hotline: +65 6546 6150 FAX : +65 6536 3969 E-mail : haulotteasia@haulotte.com www.haulotte.sg</p>		<p>HAULOTTE MIDDLE EAST FZE PO BOX 293881 Dubai Airport Free Zone DUBAI United Arab Emirates TEL : +971 (0)4 299 77 35 FAX : +971 (0) 4 299 60 28 E-mail : haulottemiddle-east@haulotte.com www.haulotte.ae</p>
	<p>HAULOTTE SCANDINAVIA AB Taljegårdsgatan 12 431 53 Mölndal SWEDEN TEL : +46 31 744 32 90 FAX : +46 31 744 32 99 E-mail : info@se.haulotte.com spares@se.haulotte.com www.haulotte.se</p>		<p>HAULOTTE TRADING (SHANGHAI) Co. Ltd. #7 WORKSHOP No 191 HUA JIN ROAD MIN HANG DISTRICT SHANGHAI 201108 CHINA TEL : +86 21 6442 6610 FAX : +86 21 6442 6619 E-mail : haulotteshanghai@haulotte.com www.haulotte.cn</p>		<p>HAULOTTE ARGENTINA Ruta Panamericana Km. 34,300 (Ramal A Escobar) 1615 Gran Bourg (Provincia de Buenos Aires) Argentina TEL : +54 33 27 445991 FAX : +54 33 27 452191 E-mail : haulotteargentina@haulotte.com www.haulotte.com.ar</p>
	<p>HAULOTTE UK Ltd 1 Gravelly Way Four Ashes Wolverhampton WV10 7GW ENGLAND TEL : +44 (0)1216 199753 FAX : +44 (0)1952 292758 E-mail : salesuk@haulotte.com www.haulotte.co.uk</p>		<p>HAULOTTE GROUP / BILJAX 125 TAYLOR PARKWAY ARCHBOLD, OH 43502 – USA TEL : +1 419 445 8915 FAX : +1 419 445 0367 Toll free : +1 800 537 0540 E-mail : sales@us.haulotte.com www.haulotte-usa.com</p>		<p>HAULOTTE NORTH AMERICA 3409 Chandler Creek Rd. VIRGINIA BEACH, VA 23453 – USA TEL : +1 757 689 2146 FAX : +1 757 689 2175 Toll free : +1 800 537 0540 E-mail : sales@us.haulotte.com www.haulotte-usa.com</p>
	<p>HAULOTTE NETHERLANDS BV Koopvaardijweg 26 4906 CV OOSTERHOUT - Nederland TEL : +31 (0) 162 670 707 FAX : +31 (0) 162 670 710 E-mail : info@haulotte.nl www.haulotte.nl</p>		<p>HAULOTTE AUSTRALIA PTY Ltd 51 Port Link Drive DANDENONG – VIC – 3175 TEL : 1 300 207 683 FAX : +61 (0)3 9792 1011 E-mail : sales@haulotte.com.au www.haulotte.com.au</p>		<p>HAULOTTE CHILE Panamerica Norte Altura Km 21,5 Colina (Cruce /Lo Pinto) Santiago (RM) TEL : + 562 2 3727630 E-mail : haulotte-chile@haulotte.com www.haulotte-chile.com</p>

G - Other information

2.1 - CALIFORNIA WARNING

For the US destined machines (ANSI and CSA standards)

<p style="text-align: center;">CALIFORNIA</p> <p style="text-align: center;"> Proposition 65 Warning</p> <p>Operating, servicing and maintaining a passenger vehicle or off-road vehicle can expose you to chemicals including engine exhaust, carbon monoxide, phthalates, and lead, which are known to the State of California to cause cancer and birth defects or other reproductive harm. To minimize exposure, avoid breathing exhaust, do not idle the engine except as necessary, service your vehicle in a well-ventilated area and wear gloves or wash your hands frequently when servicing your vehicle.</p> <p>For more information go to  www.P65Warnings.ca.gov/passenger-vehicle</p>
<p style="text-align: center;">CALIFORNIE</p> <p style="text-align: center;"> Avertissement de la Proposition 65</p> <p>L'exploitation, l'entretien et la maintenance d'un véhicule de tourisme ou d'un véhicule tout-terrain peuvent vous exposer à des produits chimiques, y compris les gaz d'échappement, le monoxyde de carbone, les phthalates et le plomb, identifiés par l'État de Californie comme pouvant causer le cancer et des malformations congénitales ou autres effets nocifs sur la reproduction. Pour limiter toute exposition: évitez de respirer les gaz d'échappement, ne laissez pas tourner le moteur au ralenti sauf si nécessaire, faites l'entretien du véhicule dans une zone bien aérée et portez des gants ou lavez vous fréquemment les mains lors de cette opération.</p> <p>Pour de plus amples informations, consulter  www.P65Warnings.ca.gov/passenger-vehicle</p>
<p style="text-align: center;">CALIFORNIA</p> <p style="text-align: center;"> Advertencia de la Proposición 65</p> <p>Operar, dar servicio y mantenimiento a un vehículo de pasajeros o vehículo todo terreno puede exponerle a químicos incluyendo gases del escape, monóxido de carbono, ftalatos y plomo, los cuales son conocidos por el Estado de California como causantes de cáncer y defectos de nacimiento u otros daños reproductivos. Para minimizar la exposición, evite respirar los gases del escape, no encienda el motor excepto si es necesario, dé servicio a su vehículo en un área bien ventilada y utilice guantes o lave sus manos frecuentemente cuando dé servicio a su vehículo.</p> <p>Para mayor información visite  www.P65Warnings.ca.gov/passenger-vehicle</p>

G - Other information

For the engine powered machines destined to the US market (Standards ANSI and CSA)

CALIFORNIA



Proposition 65 Warning

Breathing diesel engine exhaust exposes you to chemicals known to the State of California to cause cancer and birth defects or other reproductive harm.

- ✓ Always start and operate the engine in a well-ventilated area.
- ✓ If in an enclosed area, vent the exhaust to the outside.
- ✓ Do not modify or tamper with the exhaust system.
- ✓ Do not idle the engine except as necessary.

For more information go to  www.P65Warnings.ca.gov/diesel

CALIFORNIE



Avertissement de la Proposition 65

Respirer les gaz d'échappement de moteurs diesel peut vous exposer à des agents chimiques identifiés par l'État de Californie comme pouvant causer le cancer et des malformations congénitales ou autres effets nocifs sur la reproduction.

- ✓ Toujours démarrer et faire tourner le moteur dans une zone bien aérée.
- ✓ Si la zone est mal ventilée, évacuer les gaz d'échappement à l'extérieur.
- ✓ Ne pas modifier ou altérer le système d'échappement.
- ✓ Ne laisser le moteur tourner au ralenti que si cela est nécessaire.

Pour de plus amples informations, consulter  www.P65Warnings.ca.gov/diesel

CALIFORNIA



Advertencia de la Proposición 65

Respirar los gases del escape de motores a diésel le expone a químicos conocidos por el Estado de California como causantes de cáncer y defectos de nacimiento u otros daños reproductivos.

- ✓ Siempre encienda y opere el motor en un área bien ventilada.
- ✓ Si es en un área cerrada, ventile el orificio del escape hacia el exterior.
- ✓ Ne pas modifier ou altérer le système d'échappement.
- ✓ No modifique ni altere el sistema de escape.

Para mayor información visite  www.P65Warnings.ca.gov/diesel

G - Other information

For electric (battery operated) machines

CALIFORNIA



Proposition 65 Warning

Battery posts, terminals and related accessories contain lead and lead compounds, chemicals known to the State of California to cause cancer and reproductive harm. Batteries also contain other chemicals known to the State of California to cause cancer.
WASH HANDS AFTER HANDLING.

For more information go to  www.P65Warnings.ca.gov

CALIFORNIE



Avertissement de la Proposition 65

Les batteries, les bornes et autres accessoires contiennent du plomb et des composés à base de plomb, agents chimiques identifiés par l'État de Californie comme pouvant provoquer le cancer et des effets nocifs sur la reproduction. Les batteries contiennent également d'autres agents chimiques identifiés par l'Etat de Californie comme pouvant provoquer le cancer.
SE LAVER LES MAINS APRES MANIPULATION.

Pour de plus amples informations, consulter  www.P65Warnings.ca.gov

CALIFORNIA



Advertencia de la Proposición 65

Los bornes, los terminales y los accesorios de las baterías contienen plomo y compuestos de plomo, químicos conocidos por el Estado de California como causantes de cáncer y daños reproductivos. Las baterías también contienen otros químicos conocidos por el Estado de California como causantes de cáncer.
LAVESE LAS MANOS DESPUES DE MANIPULARLOS.

Para mayor información visite  www.P65Warnings.ca.gov

H - Intervention register

1 - Intervention register

The intervention register keeps a record of maintenance and repair work carried out inside or outside the maintenance programme.

N.B.: - In the case of a HAULOTTE Services® intervention, the qualified technician must indicate the HAULOTTE Services® intervention number.

Date	Type of intervention	Number of hours	Intervenor	HAULOTTE Services® intervention number

A

B

C

D

E

F

G

H

I

H - Intervention register

Date	Type of intervention	Number of hours	Intervenor	HAULOTTE Services® intervention number